

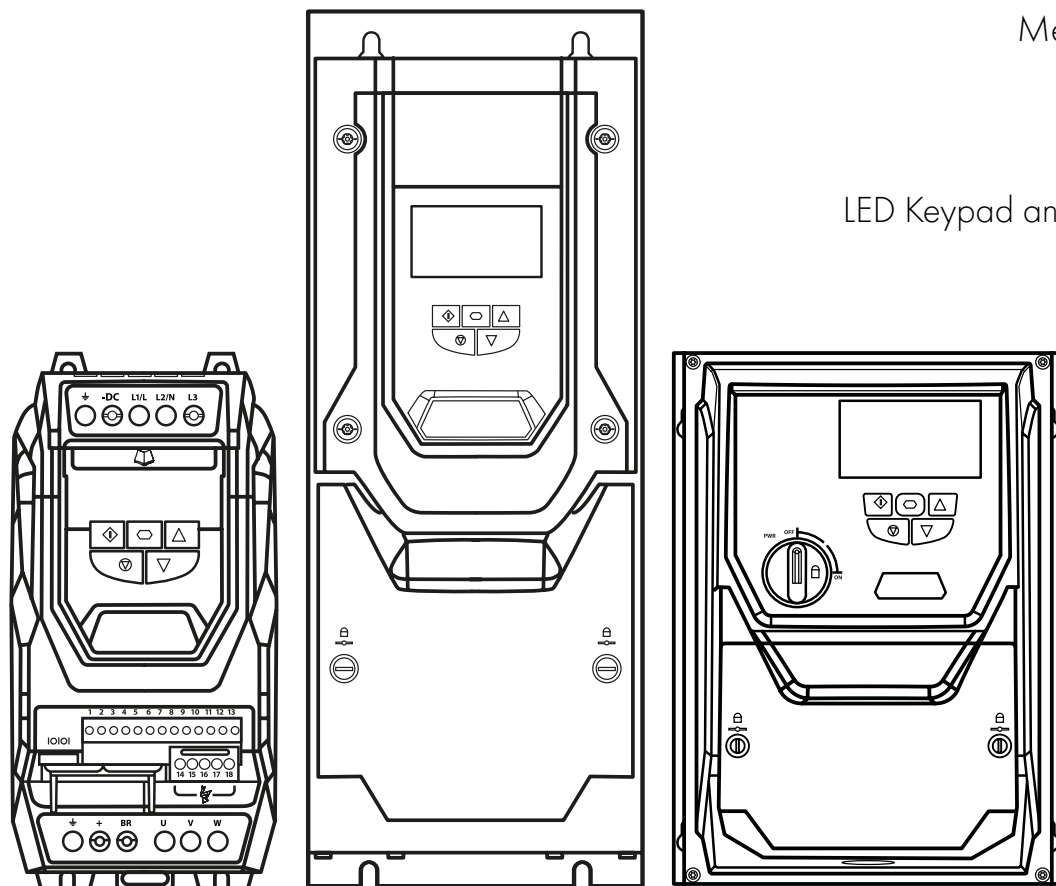

AC Variable Speed Drive

0.75 - 250kW / 1HP - 350HP
 200-600V 1 / 3 Phase Input



Introduction	1
General Information and Ratings	2
Mechanical Installation	3
Electrical Installation	4
LED Keypad and Display Operation	5
Commissioning	6
Parameters	7
Control Terminal Functions	8
Extended Parameters	9
Serial Communications	10
Technical Data	11
Troubleshooting	12

1. Introduction	4	6. Commissioning	32
1.1. Important Safety Information	4	6.1. General	32
2. General Information and Ratings	5	7. Parameters	33
2.1. Drive Model Numbers	5	7.1. Parameter Set Overview	33
2.2. Identifying the Drive by Model Number	8	7.2. Parameter Group 1 – Basic Parameters	33
3. Mechanical Installation	9	8. Control Terminal Functions	35
3.1. Before Installation	9	8.1. Digital Input Configuration Parameter P1-13	35
3.2. General	9	9. Extended Parameters	36
3.3. Mechanical Dimensions and Weight	10	9.1. Parameter Group 2 – Extended parameters	36
3.4. Guidelines for Enclosure mounting (IP20 Units)	13	9.2. Parameter Group 3 – PID Control	41
3.5. Mounting the Drive – IP20 Units	14	9.3. Parameter Group 4 – High Performance Motor Control	43
3.6. Guidelines for Mounting (IP66 Units)	14	9.4. Parameter Group 5 – Communication Parameters	44
3.7. Guidelines for Mounting (IP55 Units)	15	9.5. Parameter Group 8 – Application Function Specific Parameters	46
3.8. Removing the Terminal Cover	16	9.6. Parameter Group 0 – Monitoring Parameters (Read Only)	48
3.9. Routine Maintenance	16	10. Serial Communications	51
3.10. IP66 (Nema 4X) Gland Plate and Lock Off	16	10.1. RS-485 Communications	51
4. Electrical Installation	18	10.2. Modbus RTU Communications	52
4.1. Connection Diagram	18	10.3. BACnet MSTP	53
4.2. Incoming Power Connection	21	11. Technical Data	60
4.3. Optional Input Chokes	21	11.1. Environmental	60
4.4. Drive and Motor Connection	22	11.2. Input Voltage Ranges	60
4.5. Motor Terminal Box Connections	22	11.3. Phase Imbalance	60
4.6. Motor Thermal Overload Protection	22	11.4. Output Power and Current ratings	60
4.7. EMC Compliant Installation	23	11.5. Additional Information for UL Compliance	62
4.8. Control Terminal Wiring	23	11.6. EMC Filter Disconnect	63
4.9. Connection Diagram	23	11.7. Derating Information	64
4.10. Safe Torque Off	24	12. Troubleshooting	65
5. Keypad and Display Operation	28	12.1. Fault Messages	65
5.1. OLED Keypad and Display Layout	28		
5.2. LED Keypad and Display Layout	28		
5.3. Selecting the Language on the OLED Display	28		
5.4. Additional Display Messages	29		
5.5. Changing Parameters	30		
5.6. Parameter Factory Reset / User Reset	30		
5.7. Resetting the Drive Following a Trip	30		
5.8. Selecting Between Hand and Auto Control	31		
5.9. Keypad Short Cuts	31		

Declaration of Conformity

Invertek Drives Ltd hereby states that the Optidrive Eco product range conforms to the relevant safety provisions of the following council directives:

2014/30/EU (EMC) and 2014/35/EU (LVD)

Design and manufacture is in accordance with the following harmonised European standards:

EN 61800-5-1: 2003	Adjustable speed electrical power drive systems. Safety requirements. Electrical, thermal and energy.
EN 61800-3 2nd Ed: 2004	Adjustable speed electrical power drive systems. EMC requirements and specific test methods.
EN61000-3-12	Limits for harmonic currents produced by equipment connected to public low-voltage systems with input current > 16 A and ≤ 75 A per phase. Three phase 200V and three phase 400V Optidrive Eco products comply with IEC 61000-3-12 with respect to the THC without the need for Line Reactors, provided that the short-circuit power S_{SC} is greater than or equal to $S_{SC (min)}$ at the interface point between the user's supply and the public system. It is the responsibility of the installer or user of the equipment to ensure, by consultation with the distribution network operator if necessary, that the equipment is connected only to a supply with a short-circuit power S_{SC} greater than or equal to $S_{SC (min)}$ calculated as: $S_{SC (min)} = 320 \times V_{rated} \times I_{rated}$ Where V_{rated} is the drive rated voltage (phase to phase) and I_{rated} is the drive rated current (per phase)
EN 55011: 2007	Limits and Methods of measurement of radio disturbance characteristics of industrial, scientific and medical (ISM) radio-frequency equipment (EMC).
EN60529: 1992	Specifications for degrees of protection provided by enclosures.

Electromagnetic Compatibility

All Optidrives are designed with high standards of EMC in mind. All versions intended for use within the European Union are fitted with an internal EMC filter. This EMC filter is designed to reduce the conducted emissions back into the supply via the power cables for compliance with harmonised European standards.

It is the responsibility of the installer to ensure that the equipment or system into which the product is incorporated complies with the EMC legislation of the country of use. Within the European Union, equipment into which this product is incorporated must comply with the EMC Directive 2004/108/EC. When using an Optidrive with an internal or optional external filter, compliance with the following EMC Categories, as defined by EN61800-3:2004 can be achieved:

Copyright Invertek Drives Ltd © 2015

All rights reserved. No part of this User Guide may be reproduced or transmitted in any form or by any means, electrical or mechanical including photocopying, recording or by any information storage or retrieval system without permission in writing from the publisher.

2 Year Warranty

All Invertek Optidrive Eco units carry a 2 year warranty against manufacturing defects from the date of manufacture. The manufacturer accepts no liability for any damage caused during or resulting from transport, receipt of delivery, installation or commissioning. The manufacturer also accepts no liability for damage or consequences resulting from inappropriate, negligent or incorrect installation, incorrect adjustment of the operating parameters of the drive, incorrect matching of the drive to the motor, incorrect installation, unacceptable dust, moisture, corrosive substances, excessive vibration or ambient temperatures outside of the design specification.

The local distributor may offer different terms and conditions at their discretion, and in all cases concerning warranty, the local distributor should be contacted first.

This user guide is the “original instructions” document. All non-English versions are translations of the “original instructions”.

The contents of this User Guide are believed to be correct at the time of printing. In the interest of a commitment to a policy of continuous improvement, the manufacturer reserves the right to change the specification of the product or its performance or the contents of the User Guide without notice.

This User Guide is for use with version 2.30 Firmware. The firmware version can be viewed in parameter P0-28.

User Guide Revision 3.03

Invertek Drives Ltd adopts a policy of continuous improvement and whilst every effort has been made to provide accurate and up to date information, the information contained in this User Guide should be used for guidance purposes only and does not form the part of any contract.

1. Introduction

1.1. Important Safety Information

Please read the IMPORTANT SAFETY INFORMATION below, and all Warning and Caution information elsewhere.



Danger: Indicates a risk of electric shock, which, if not avoided, could result in damage to the equipment and possible injury or death.

This variable speed drive product (Optidrive) is intended for professional incorporation into complete equipment or systems as part of a fixed installation. If installed incorrectly it may present a safety hazard. The Optidrive uses high voltages and currents, carries a high level of stored electrical energy, and is used to control mechanical plant that may cause injury. Close attention is required to system design and electrical installation to avoid hazards in either normal operation or in the event of equipment malfunction. Only qualified electricians are allowed to install and maintain this product.

System design, installation, commissioning and maintenance must be carried out only by personnel who have the necessary training and experience. They must carefully read this safety information and the instructions in this Guide and follow all information regarding transport, storage, installation and use of the Optidrive, including the specified environmental limitations.

Do not perform any flash test or voltage withstand test on the Optidrive. Any electrical measurements required should be carried out with the Optidrive disconnected. Internal surge arrestors are fitted, intended to protect against damage due to mains borne spikes, which will result in the product failing the flash test.

Electric shock hazard! Disconnect and ISOLATE the Optidrive before attempting any work on it. High voltages are present at the terminals and within the drive for up to 10 minutes after disconnection of the electrical supply. Always ensure by using a suitable multimeter that no voltage is present on any drive power terminals prior to commencing any work.

Where supply to the drive is through a plug and socket connector, do not disconnect until 10 minutes have elapsed after turning off the supply.

Ensure correct earthing connections and cable selection as per defined by local legislation or codes. The drive may have a leakage current of greater than 3.5mA; furthermore the earth cable must be sufficient to carry the maximum supply fault current which normally will be limited by the fuses or MCB. Suitably rated fuses or MCB should be fitted in the mains supply to the drive, according to any local legislation or codes.

Do not carry out any work on the drive control cables whilst power is applied to the drive or to the external control circuits.



Danger: Indicates a potentially hazardous situation other than electrical, which if not avoided, could result in damage to property.

Within the European Union, all machinery in which this product is used must comply with Directive 98/37/EC, Safety of Machinery. In particular, the machine manufacturer is responsible for providing a main switch and ensuring the electrical equipment complies with EN60204-1.

The level of integrity offered by the Optidrive control input functions – for example stop/start, forward/reverse and maximum speed, is not sufficient for use in safety-critical applications without independent channels of protection. All applications where malfunction could cause injury or loss of life must be subject to a risk assessment and further protection provided where needed.

The driven motor can start at power up if the enable input signal is present.

The STOP function does not remove potentially lethal high voltages. ISOLATE the drive and wait 10 minutes before starting any work on it. Never carry out any work on the Drive, Motor or Motor cable whilst the input power is still applied.

The Optidrive can be programmed to operate the driven motor at speeds above or below the speed achieved when connecting the motor directly to the mains supply. Obtain confirmation from the manufacturers of the motor and the driven machine about suitability for operation over the intended speed range prior to machine start up.

Do not activate the automatic fault reset function on any systems whereby this may cause a potentially dangerous situation.

Optidrives are intended for indoor use only.

When mounting the drive, ensure that sufficient cooling is provided. Do not carry out drilling operations with the drive in place, dust and swarf from drilling may lead to damage.

The entry of conductive or flammable foreign bodies should be prevented. Flammable material should not be placed close to the drive.

Relative humidity must be less than 95% (non-condensing).

Ensure that the supply voltage, frequency and no. of phases (1 or 3 phase) correspond to the rating of the Optidrive as delivered.

Never connect the mains power supply to the Output terminals U, V, W.

Do not install any type of automatic switchgear between the drive and the motor. This may cause the drive protection to activate, resulting in a trip and loss of operation.

Wherever control cabling is close to power cabling, maintain a minimum separation of 100 mm and arrange crossings at 90 degrees.

Ensure that all terminals are tightened to the appropriate torque setting.

Do not attempt to carry out any repair of the Optidrive. In the case of suspected fault or malfunction, contact your local Inverter Drives Sales Partner for further assistance.

2. General Information and Ratings

2.1. Drive Model Numbers

2.1.1. IP20 Units

200 – 240 Volt, 1 Phase Input					
Model Code	Frame	kW	HP	Amps	Low Harmonic
ODV-3-220043-1F12-SN	2	0.75	1	4.3	No
ODV-3-220070-1F12-SN	2	1.5	2	7	No
ODV-3-220105-1F12-SN	2	2.2	3	10.5	No
200 – 240 Volt, 3 Phase Input					
Model Code	Frame	kW	HP	Amps	Low Harmonic
ODV-3-220043-3F12-SN	2	0.75	1	4.3	Yes
ODV-3-220070-3F12-SN	2	1.5	2	7	Yes
ODV-3-220105-3F12-SN	2	2.2	3	10.5	Yes
ODV-3-320180-3F12-SN	3	4	5	18	Yes
ODV-3-320240-3F12-SN	3	5.5	7.5	24	Yes
ODV-3-420300-3F12-TN	4	7.5	10	30	Yes
ODV-3-420460-3F12-TN	4	11	15	46	Yes
ODV-3-520610-3F12-TN	5	15	20	61	Yes
ODV-3-520720-3F12-TN	5	18.5	25	72	Yes
ODV-3-520900-3F12-TN	5	22	30	90	Yes
380 – 480 Volt, 3 Phase Input					
Model Code	Frame	kW	HP	Amps	Low Harmonic
ODV-3-240022-3F12-SN	2	0.75	1	2.2	Yes
ODV-3-240041-3F12-SN	2	1.5	2	4.1	Yes
ODV-3-240058-3F12-SN	2	2.2	3	5.8	Yes
ODV-3-240095-3F12-SN	2	4	5	9.5	Yes
ODV-3-340140-3F12-SN	3	5.5	7.5	14	Yes
ODV-3-340180-3F12-SN	3	7.5	10	18	Yes
ODV-3-340240-3F12-SN	3	11	15	24	Yes
ODV-3-440300-3F12-TN	4	15	20	30	Yes
ODV-3-440390-3F12-TN	4	18.5	25	39	Yes
ODV-3-440460-3F12-TN	4	22	30	46	Yes
ODV-3-540610-3F12-TN	5	30	40	61	Yes
ODV-3-540720-3F12-TN	5	37	50	72	Yes
ODV-3-540900-3F12-TN	5	45	60	90	Yes
ODV-3-843700-3F12-TN	8	200	300	370	No
ODV-3-844500-3F12-TN	8	250	350	450	No
500 – 600 Volt, 3 Phase Input					
Model Code	Frame	kW	HP	Amps	Low Harmonic
ODV-3-260021-3012-SN	2	0.75	1	2.1	No
ODV-3-260031-3012-SN	2	1.5	2	3.1	No
ODV-3-260041-3012-SN	2	2.2	3	4.1	No
ODV-3-260065-3012-SN	2	4	5	6.5	No
ODV-3-260090-3012-SN	2	5.5	7.5	9	No
ODV-3-360120-3012-SN	3	7.5	10	12	No
ODV-3-360170-3012-SN	3	11	15	17	No
ODV-3-360220-3012-SN	3	15	20	22	No
ODV-3-460220-3012-TN	4	15	20	22	No
ODV-3-460280-3012-TN	4	18.5	25	28	No
ODV-3-460340-3012-TN	4	22	30	34	No
ODV-3-460430-3012-TN	4	30	40	43	No
ODV-3-560540-3012-TN	5	37	50	54	No
ODV-3-560650-3012-TN	5	45	60	65	No

2.1.2. IP66 Enclosed Units

200 – 240 Volt, 1 Phase Input						
Non Switched	With Disconnect	Frame	kW	HP	Amps	Low Harmonic
ODV-3-220043-1F1X-TN	ODV-3-220043-1F1D-TN	2A	0.75	1	4.3	No
ODV-3-220070-1F1X-TN	ODV-3-220070-1F1D-TN	2A	1.5	2	7	No
ODV-3-220105-1F1X-TN	ODV-3-220105-1F1D-TN	2A	2.2	3	10.5	No
200 – 240 Volt, 3 Phase Input						
Non Switched	With Disconnect	Frame	kW	HP	Amps	Low Harmonic
ODV-3-220043-3F1X-TN	ODV-3-220043-3F1D-TN	2A	0.75	1	4.3	Yes
ODV-3-220070-3F1X-TN	ODV-3-220070-3F1D-TN	2A	1.5	2	7	Yes
ODV-3-220105-3F1X-TN	ODV-3-220105-3F1D-TN	2A	2.2	3	10.5	Yes
ODV-3-320180-3F1X-TN	ODV-3-320180-3F1D-TN	3	4	5	18	Yes
ODV-3-320240-3F1X-TN	ODV-3-320240-3F1D-TN	3	5.5	7.5	24	Yes
380 – 480 Volt, 3 Phase Input						
Non Switched	With Disconnect	Frame	kW	HP	Amps	Low Harmonic
ODV-3-240022-3F1X-TN	ODV-3-240022-3F1D-TN	2A	0.75	1	2.2	Yes
ODV-3-240041-3F1X-TN	ODV-3-240041-3F1D-TN	2A	1.5	2	4.1	Yes
ODV-3-240058-3F1X-TN	ODV-3-240058-3F1D-TN	2A	2.2	3	5.8	Yes
ODV-3-240095-3F1X-TN	ODV-3-240095-3F1D-TN	2B	4	5	9.5	Yes
ODV-3-340140-3F1X-TN	ODV-3-340140-3F1D-TN	3	5.5	7.5	14	Yes
ODV-3-340180-3F1X-TN	ODV-3-340180-3F1D-TN	3	7.5	10	18	Yes
ODV-3-340240-3F1X-TN	ODV-3-340240-3F1D-TN	3	11	15	24	Yes
500 – 600 Volt, 3 Phase Input						
Non Switched	With Disconnect	Frame	kW	HP	Amps	Low Harmonic
ODV-3-260021-301X-TN	ODV-3-260021-301D-TN	2A	0.75	1	2.1	No
ODV-3-260031-301X-TN	ODV-3-260031-301D-TN	2A	1.5	2	3.1	No
ODV-3-260041-301X-TN	ODV-3-260041-301D-TN	2A	2.2	3	4.1	No
ODV-3-260065-301X-TN	ODV-3-260065-301D-TN	2A	4	5	6.5	No
ODV-3-260090-301X-TN	ODV-3-260090-301D-TN	2A	5.5	7.5	9	No
ODV-3-360120-301X-TN	ODV-3-360120-301D-TN	3	7.5	10	12	No
ODV-3-360170-301X-TN	ODV-3-360170-301D-TN	3	11	15	17	No

2.1.3. IP55 Enclosed Units

200 – 240 Volt, 3 Phase Input					
Model Code	Frame	kW	HP	Amps	Low Harmonic
ODV-3-420300-3F1N-TN	4	7.5	10	30	Yes
ODV-3-420460-3F1N-TN	4	11	15	46	Yes
ODV-3-520610-3F1N-TN	5	15	20	61	Yes
ODV-3-520720-3F1N-TN	5	18.5	25	72	Yes
ODV-3-620900-3F1N-TN	5	22	30	90	Yes
ODV-3-621100-3F1N-TN	6	30	40	110	No
ODV-3-621500-3F1N-TN	6	37	50	150	No
ODV-3-621800-3F1N-TN	6	45	60	180	No
ODV-3-722020-3F1N-TN	7	55	75	202	No
ODV-3-722480-3F1N-TN	7	75	100	248	No
380 – 480 Volt, 3 Phase Input					
Model Code	Frame	kW	HP	Amps	Low Harmonic
ODV-3-440300-3F1N-TN	4	15	20	30	Yes
ODV-3-440390-3F1N-TN	4	18.5	25	39	Yes
ODV-3-440460-3F1N-TN	4	22	30	46	Yes
ODV-3-540610-3F1N-TN	5	30	40	61	Yes
ODV-3-540720-3F1N-TN	5	37	50	72	Yes
ODV-3-540900-3F1N-TN	5	45	60	90	Yes
ODV-3-641100-3F1N-TN	6	55	75	110	No
ODV-3-641500-3F1N-TN	6	75	100	150	No
ODV-3-641800-3F1N-TN	6	90	150	180	No
ODV-3-742020-3F1N-TN	7	110	175	202	No
ODV-3-742400-3F1N-TN	7	132	200	240	No
ODV-3-743020-3F1N-TN	7	160	250	302	No
480 – 525 Volt, 3 Phase Input					
Model Code	Frame	kW	HP	Amps	Low Harmonic
ODV-3-751850-301N-TN	7	132	175	185	No
ODV-3-752050-301N-TN	7	150	200	205	No
ODV-3-752550-301N-TN	7	185	250	255	No
ODV-3-752750-301N-TN	7	200	270	275	No
500 – 600 Volt, 3 Phase Input					
Model Code	Frame	kW	HP	Amps	Low Harmonic
ODV-3-460220-301N-TN	4	15	20	22	No
ODV-3-460280-301N-TN	4	18.5	25	28	No
ODV-3-460340-301N-TN	4	22	30	34	No
ODV-3-460430-301N-TN	4	30	40	43	No
ODV-3-560540-301N-TN	5	37	50	54	No
ODV-3-560650-301N-TN	5	45	60	65	No
ODV-3-660780-301N-TN	6	55	75	78	No
ODV-3-661050-301N-TN	6	75	100	105	No
ODV-3-661300-301N-TN	6	90	125	130	No
ODV-3-661500-301N-TN	6	110	150	150	No

2.1.4. Low Harmonic Variants

The majority of the Optidrive Eco product range is based on a low harmonic solution using film capacitor technology to achieve compliance with EN 61000-3-12 without the need for any additional equipment. This standard specifies limits for harmonic currents for equipment connected to public low-voltage systems with input current > 16A and <= 75A per phase. It is important to understand which models from the product range are of the low harmonic technology which is detailed below.

The Optidrive Eco three phase 200V (200-240V) input and three phase 400V (380-480V) input drives frame sizes 2 up to and including frame size 5 are a lower harmonic drive using film capacitor technology. Please refer to the product rating tables in section 2.1. Drive Model Numbers for confirmation.

In short, this means that the low harmonic drives do not require an input choke and should not have one installed – drives outside of the above frame sizes and supply voltage / number of phases, are of standard electrolytic capacitor design and could benefit from the use of input chokes if further harmonic reduction is required.

2.2. Identifying the Drive by Model Number

Each drive can be identified by its model number, shown below. The model number is on the shipping label and the drive nameplate. The model number includes the drive and factory fitted options.

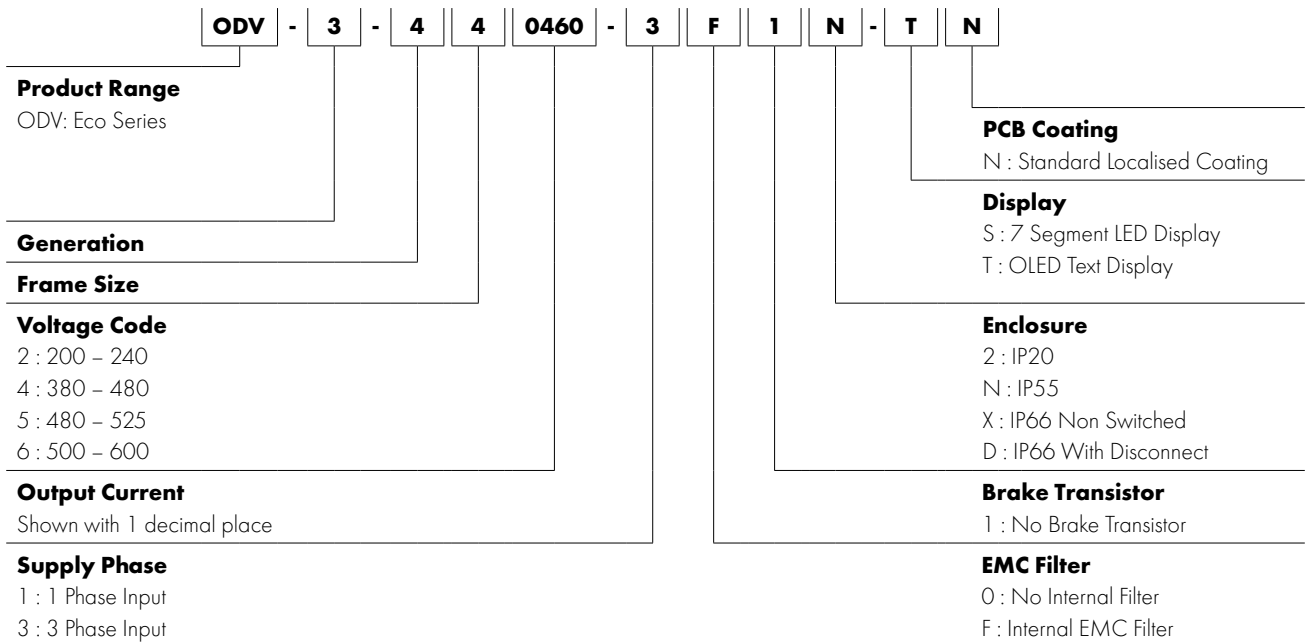

3. Mechanical Installation

3.1. Before Installation

- Carefully Unpack the Optidrive and check for any signs of damage. Notify the shipper immediately if any exist.
- Check the drive rating label to ensure it is of the correct type and power requirements for the application.
- To prevent accidental damage always store the Optidrive in its original box until required. Storage should be clean and dry and within the temperature range -40°C to $+60^{\circ}\text{C}$.

3.2. General

- The Optidrive should be mounted in a vertical position only, on a flat, flame resistant, vibration free mounting using the integral mounting holes.
- Do not mount flammable material close to the Optidrive.
- Ensure that the minimum cooling air gaps, as detailed in sections 3.4 Guidelines for Enclosure mounting (IP20 Units), 3.6. Guidelines for Mounting (IP66 Units) and 3.7. Guidelines for Mounting (IP55 Units) are left clear.
- Ensure that the ambient temperature range does not exceed the permissible limits for the Optidrive given in section 11.1. Environmental.
- Provide suitable clean, moisture and contaminant free cooling air sufficient to fulfil the cooling requirements of the Optidrive.

3.3. Mechanical Dimensions and Weight

3.3.1. IP20 Units

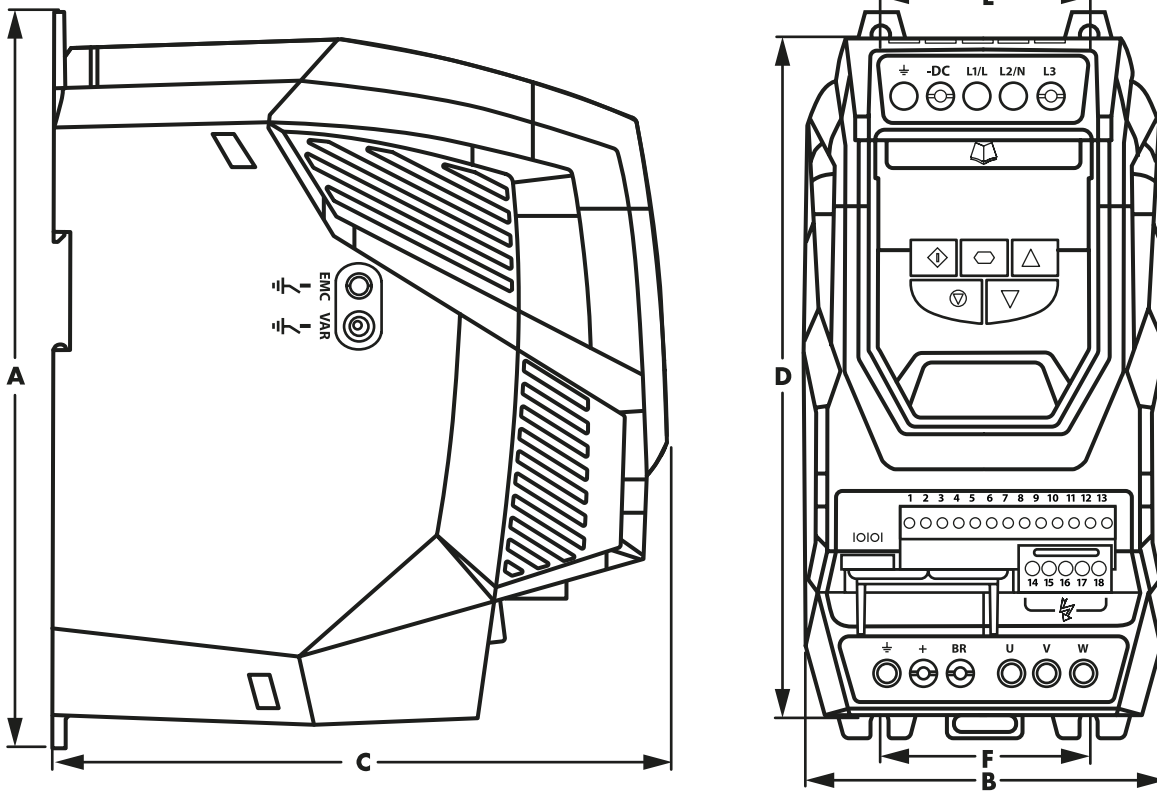

Drive Size	A		B		C		D		E		F		Weight	
	mm	in	mm	in	mm	in	mm	in	mm	in	mm	in	Kg	lb
2	221	8.70	110	4.33	185	7.28	209	8.23	63	2.48	63	2.48	1.8	4.0
3	261	10.28	131	5.16	205	8.07	247	9.72	80	3.15	80	3.15	3.5	7.7
4	418	16.46	160	6.30	240	9.45	400	15.75	125	4.92	125	4.92	9.2	20.3
5	486	19.13	222	8.74	260	10.24	460	18.11	175	6.89	175	6.89	18.1	39.9

Mounting Bolts		
Frame Size	Metric	UNF
2	M4	#8
3	M4	#8
4*	M8	5/16
5	M8	5/16

Tightening Torques			
	Frame Size	Required Torque	
Control Terminals	All	0.5 Nm	4.5 lb-in
	2 & 3	1 Nm	9 lb-in
Power Terminals	4	2 Nm	18 lb-in
	5	4 Nm	35.5 lb-in

NOTE *The IP20 Frame Size 4 Chassis can obstruct the rotation (tightening) of a bolt or screw with a hex head, a fixing with a round head will be most suitable for the mounting of this unit.

3.3.2. IP66 Units

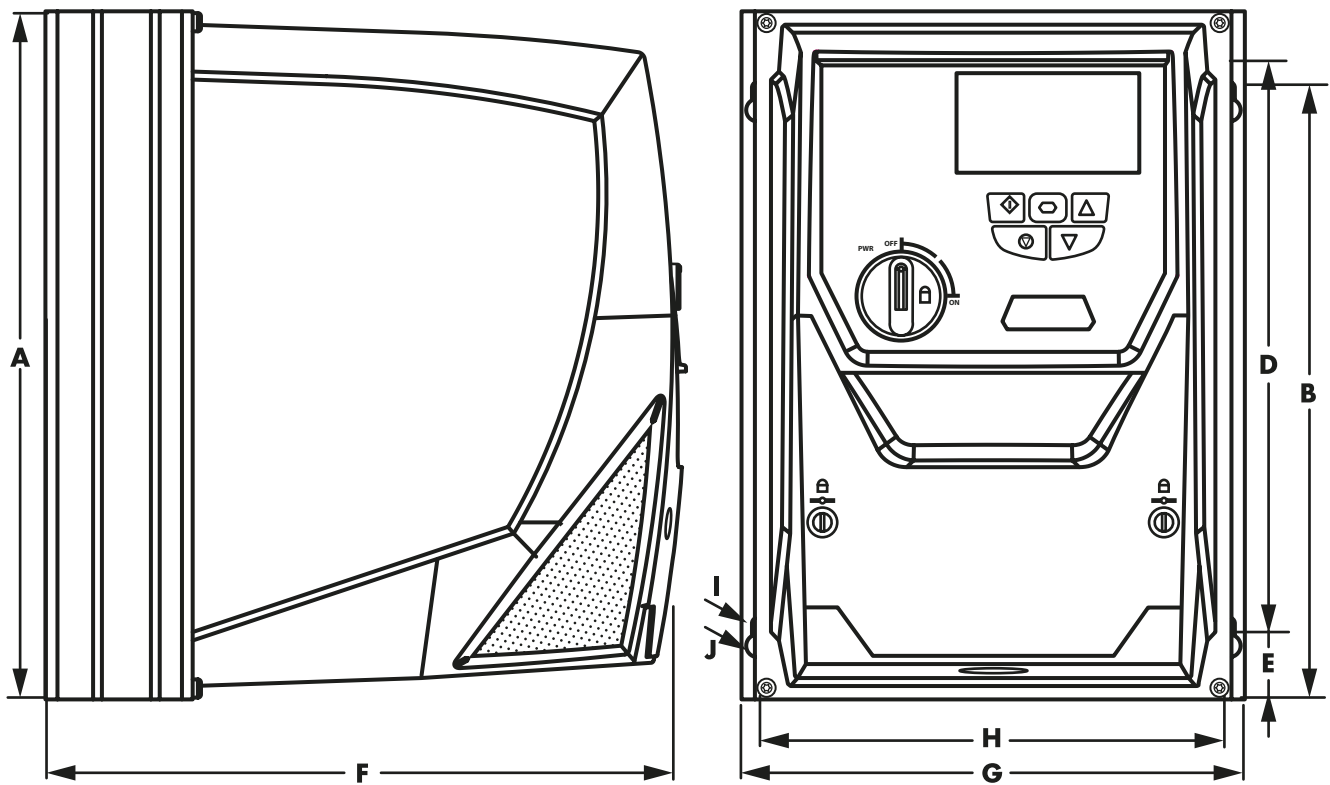

Drive Size	A		B		D		E		F		G		H		I		J		Weight	
	mm	in	mm	in	mm	in	mm	in	mm	in	mm	in	mm	in	mm	in	mm	in	kg	lb
2	257	10.12	220	8.66	200	7.87	29	1.12	239	9.41	188	7.40	178	7.01	4.2	0.17	8.5	0.33	4.8	10.6
3	310	12.20	277	10.89	252	9.90	33	1.31	266	10.47	211	8.29	200	7.87	4.2	0.17	8.5	0.33	7.7	16.8

Mounting Bolts		
Frame Size	Metric	UNF
2	M4	#8
3	M4	#8

Tightening Torques			
	Frame Size	Required Torque	
Control Terminals	All	0.5 Nm	4.5 lb-in
Power Terminals	2 & 3	1 Nm	9 lb-in

3.3.3. IP55 Units

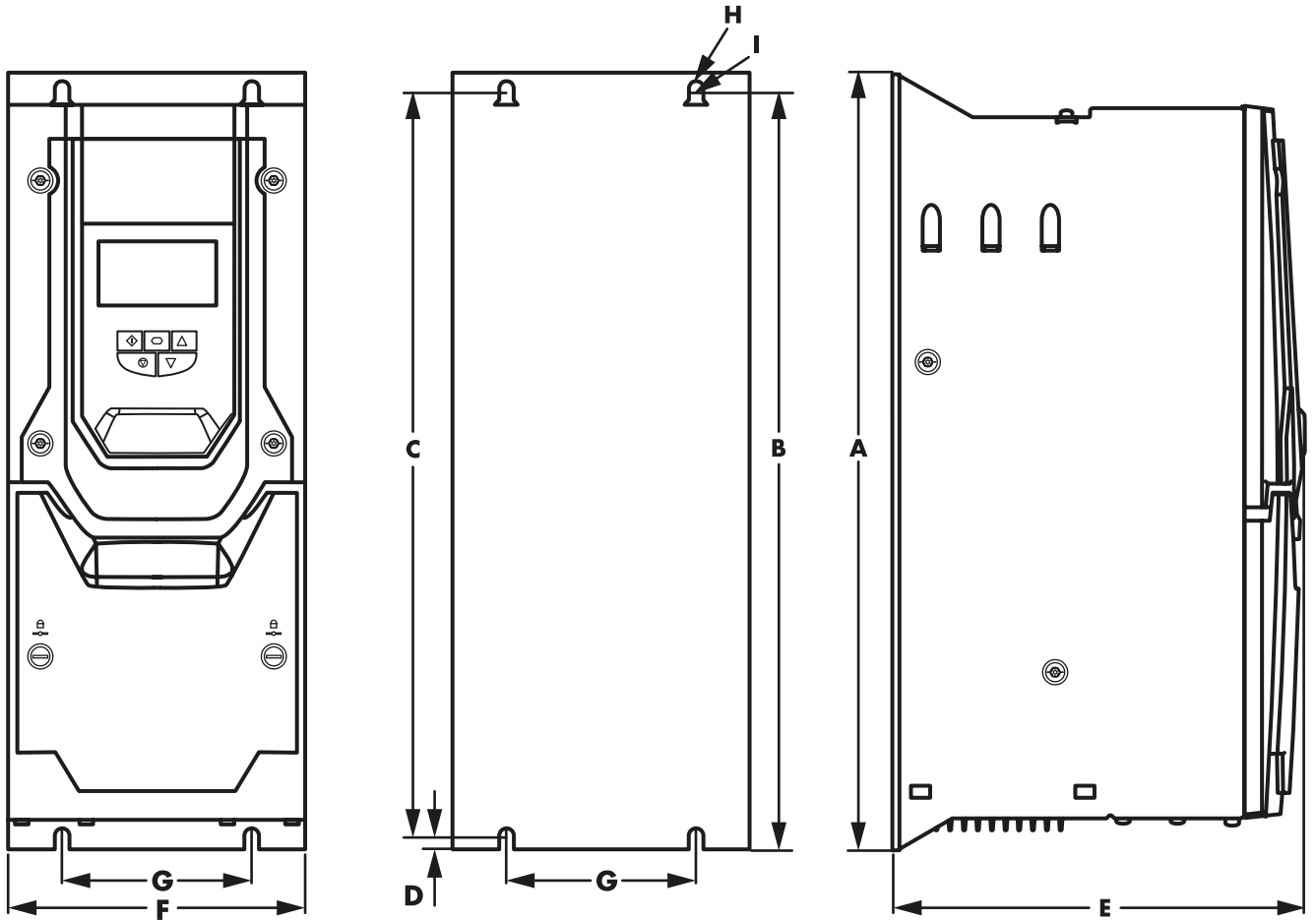

Drive Size	A		B		C		D		E		F		G		H		I		Weight	
	mm	in	mm	in	mm	in	mm	in	mm	in	mm	in	mm	in	mm	in	mm	in	kg	lb
4	450	17.72	433	17.05	428	16.85	8	0.31	252	9.92	171	6.73	110	4.33	4.25	0.17	7.5	0.30	11.5	25.4
5	540	21.26	520	20.47	515	20.28	8	0.31	270	10.63	235	9.25	175	6.89	4.25	0.17	7.5	0.30	23	50.7
6	865	34.06	840	33.07	830	32.68	10	0.39	330	12.99	330	12.99	200	7.87	5.5	0.22	11	0.43	55	121.2
7	1280	50.39	1255	49.41	1245	49.02	10	0.39	360	14.17	330	12.99	200	7.87	5.5	0.22	11	0.43	89	196.2

Mounting Bolts		
Frame Size	Metric	UNF
4	M8	#8
5	M8	#8
6	M10	5/16
7	M10	5/16

Tightening Torques			
	Frame Size	Required Torque	
Control Terminals	All	0.5 Nm	4.5 lb-in
	4	2 Nm	18 lb-in
Power Terminals	5	4 Nm	35.5 lb-in
	6	15 Nm	11 lb-ft
	7	15 Nm	11 lb-ft



3.4 Guidelines for Enclosure mounting (IP20 Units)

- IP20 drives are suitable for use in pollution degree 1 environments, according to IEC-664-1. For pollution degree 2 or higher environments, drives should be mounted in a suitable control cabinet with sufficient ingress protection to maintain a pollution degree 1 environment around the drive.
- Enclosures should be made from a thermally conductive material.
- Ensure the minimum air gap clearances around the drive as shown below are observed when mounting the drive.
- Where ventilated enclosures are used, there should be venting above the drive and below the drive to ensure good air circulation. Air should be drawn in below the drive and expelled above the drive.
- In any environments where the conditions require it, the enclosure must be designed to protect the Optidrive against ingress of airborne dust, corrosive gases or liquids, conductive contaminants (such as condensation, carbon dust, and metallic particles) and sprays or splashing water from all directions.
- High moisture, salt or chemical content environments should use a suitably sealed (non-vented) enclosure.

The enclosure design and layout should ensure that the adequate ventilation paths and clearances are left to allow air to circulate through the drive heatsink. Inverter Drives recommend the following minimum sizes for drives mounted in non-ventilated metallic enclosures:

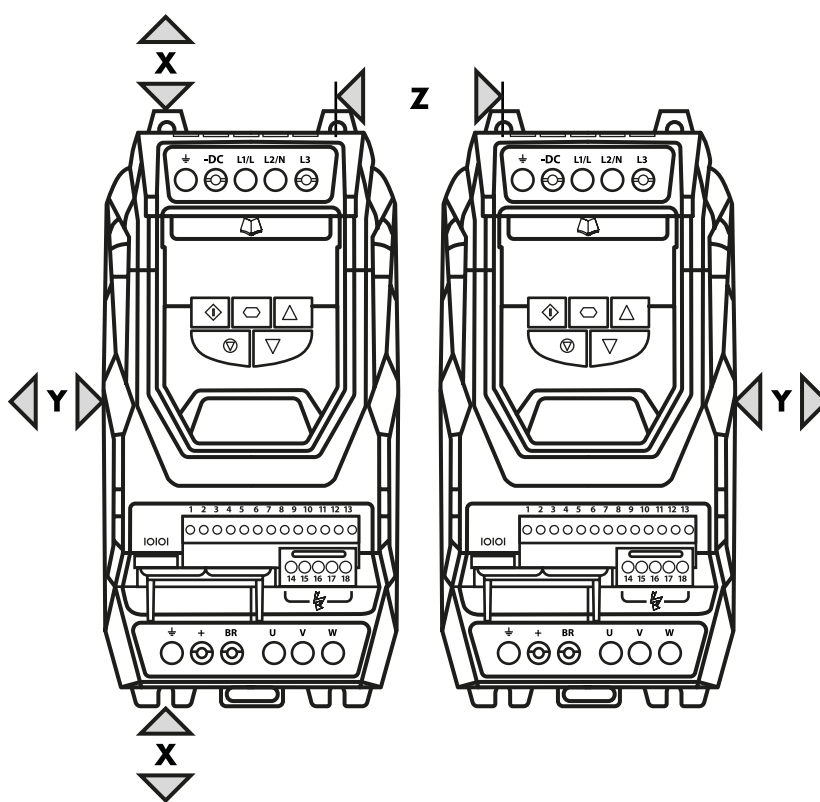

Drive Size	X Above & Below		Y Either Side		Z Between		Recommended airflow	
	mm	in	mm	in	mm	in	m3/min	CFM
2	75	2.95	10	0.39	46	1.81	0.3	11
3	100	3.94	10	0.39	52	2.05	0.9	31
4	200	7.87	25	0.98	70	2.76	1.7	62
5	200	7.87	25	0.98	70	2.76	2.9	104
8	300	11.81	100	3.94			20	705

NOTE Dimension Z assumes that the drives are mounted side-by-side with no clearance.
 Typical drive heat losses are 2% of operating load power.
 The above dimensions are for guidance only, the operating ambient temperature of the drive **MUST** be maintained within the specified limits or allowed derating at all times.

3.5. Mounting the Drive – IP20 Units

- IP20 Units are intended for installation within a control cabinet.
- When mounting with screws:
 - Using the drive as a template, or the dimensions shown above, mark the locations for drilling
 - Ensure that when mounting locations are drilled, the dust from drilling does not enter the drive
 - Mount the drive to the cabinet backplate using suitable M5 mounting screws
 - Position the drive, and tighten the mounting screws securely.
- When Din Rail Mounting (Frame Size 2 Only):
 - Locate the DIN rail mounting slot on the rear of the drive onto the top of the DIN rail first
 - Press the bottom of the drive onto the DIN rail until the lower clip attaches to the DIN rail
 - If necessary, use a suitable flat blade screw driver to pull the DIN rail clip down to allow the drive to mount securely on the rail
 - To remove the drive from the DIN rail, use a suitable flat blade screwdriver to pull the release tab downwards, and lift the bottom of the drive away from the rail first.

3.6. Guidelines for Mounting (IP66 Units)

- Before mounting the drive, ensure that the chosen location meets the environmental condition requirements for the drive shown in section 11.1. Environmental.
- The drive must be mounted vertically, on a suitable flat surface.
- The minimum mounting clearances as shown in the table below must be observed.
- The mounting site and chosen mountings should be sufficient to support the weight of the drives.
- Using the drive as a template, or the dimensions shown below, mark the locations required for drilling.
- Suitable cable glands to maintain the ingress protection of the drive are required. Gland holes for power and motor cables are pre-moulded into the drive enclosure, recommended gland sizes are shown above. Gland holes for control cables may be cut as required.

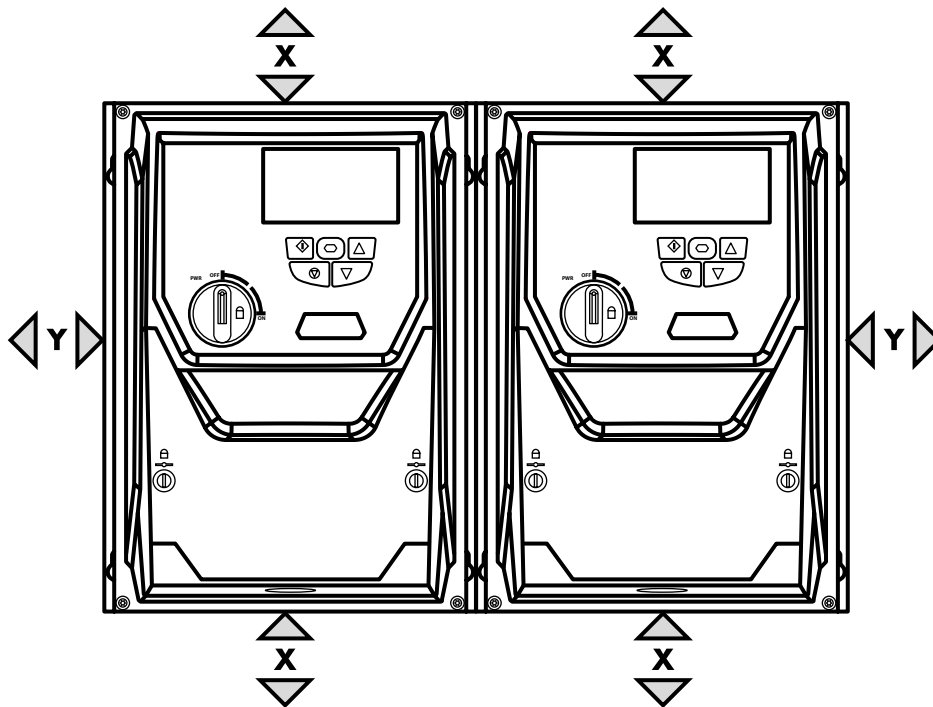

Drive Size	X Above & Below		Y Either Side		Cable Gland Sizes			
	mm	in	mm	in	Frame	Power Cable	Motor Cable	Control Cables
2	200	7.87	10	0.39	2	M25 (PG21)	M25 (PG21)	M20 (PG13.5)
3	200	7.87	10	0.39	3	M25 (PG21)	M25 (PG21)	M20 (PG13.5)

NOTE Typical drive heat losses are 2% of operating load power.
 The above dimensions are for guidance only, the operating ambient temperature of the drive MUST be maintained within the specified limits or allowed derating at all times.



3.7. Guidelines for Mounting (IP55 Units)

- Before mounting the drive, ensure that the chosen location meets the environmental condition requirements for the drive shown in section 11.1. Environmental.
- The drive must be mounted vertically, on a suitable flat surface.
- The minimum mounting clearances as shown in the table below must be observed.
- The mounting site and chosen mountings should be sufficient to support the weight of the drives.
- IP55 units do not require mounting inside an electrical control cabinet; however they may be if desired.
- Using the drive as a template, or the dimensions shown above, mark the locations required for drilling
- Suitable cable glands to maintain the IP protection of the drive are required. Gland sizes should be selected based on the number and size of the required connection cables. Drives are supplied with a plain, undrilled gland plate to allow the correct hole sizes to be cut as required. Remove the gland plate from the drive prior to drilling.

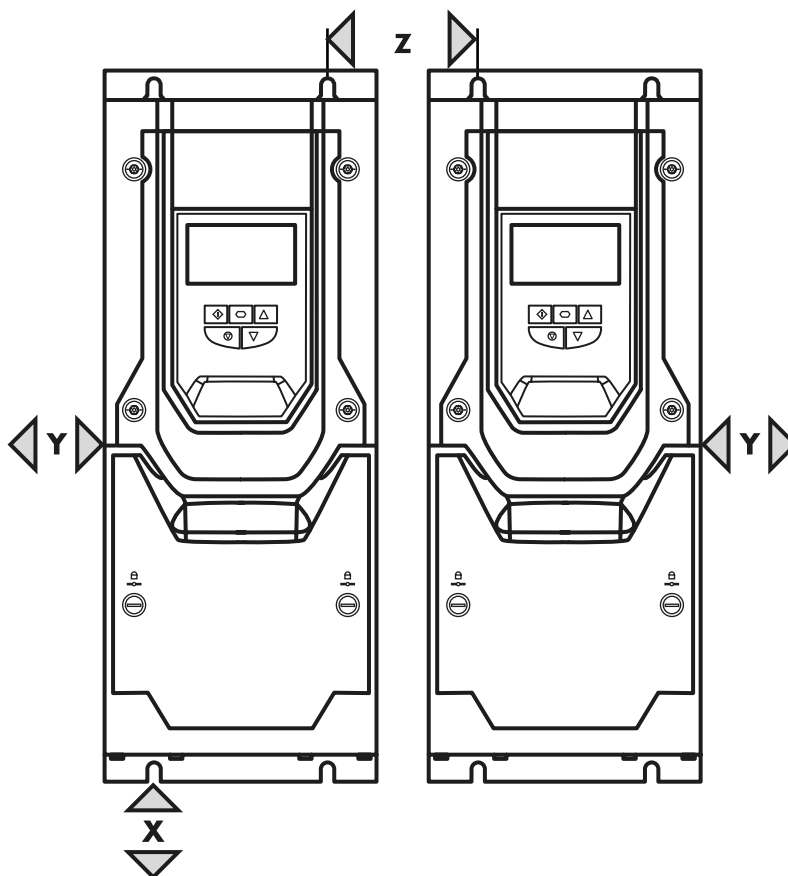

Drive Size	X Above & Below		Y Either Side	
	mm	in	mm	in
2 (IP66)	200	5.9	10	0.394
3 (IP66)	200	5.9	10	0.394
4 (IP55)	200	7.9	10	0.394
5 (IP55)	200	7.9	10	0.394
6 (IP55)	200	7.9	10	0.394
7 (IP55)	200	7.9	10	0.394

NOTE Typical drive heat losses are approximately 2% of the operating load power. The above dimensions are for guidance only, the operating ambient temperature of the drive **MUST** be maintained within the specified limits or allowed derating at all times.

3.8. Removing the Terminal Cover

All IP55 & IP66 enclosed models use quarter turn fasteners to secure the covers. The fastener positions are marked as shown below. The following diagrams show the open and closed (lock) position of the fasteners. Apply a slight pressure to the cover whilst turning the fastener to aid release.

Terminal Cover Release Screws

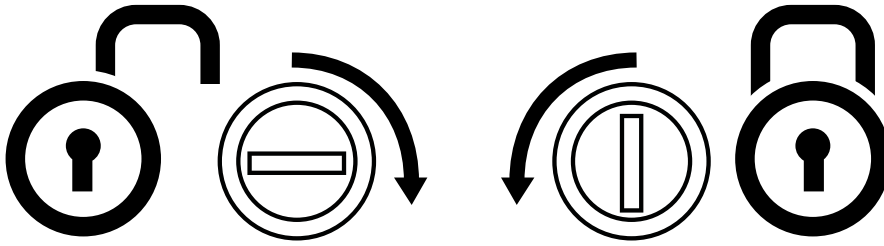

Locked (Closed) Position

Unlocked (Release) Position

3.9. Routine Maintenance

The drive should be included within the scheduled maintenance program so that the installation maintains a suitable operating environment, this should include:

- Ambient temperature is at or below that set out in the section 11.1. Environmental, with any relevant derating applied.
- Heat sink fans (where fitted) freely rotating and are dust free.
- If the drive is mounted within an enclosure:
 - Ensure this is free from dust and condensation.
 - Ensure sufficient ventilation of fresh clean cooling air is provided.
 - Ensure any panel ventilation fans and air filters are clean and provide the correct required air flow.
- Checks should also be made on all electrical connections, ensuring screw terminals are correctly torqued; and that power cables have no signs of heat damage.

3.10. IP66 (Nema 4X) Gland Plate and Lock Off

The use of a suitable gland system is required to maintain the appropriate IP / Nema rating. Cable entry holes will need to be drilled to suit this system. Some guidelines sizes are defined below:

Please take care when drilling to avoid leaving any particles within the product.

Cable Gland recommended Hole Sizes & types:

Drive size	Min Gland Rating	Hole Size	Imperial	Metric
Size 2	IP66	1 x 20.5mm and 2 x 28.3mm	1 PG13.5 and 2 PG21	1 x M20 and 2 x M25
Size 3	IP66	1 x 20.5mm and 2 x 28.3mm	1 PG13.5 and 2 PG21	1 x M20 and 2 x M25

- UL rated ingress protection ("Type ") is only met when cables are installed using a UL recognized bushing or fitting for a flexible-conduit system which meets the required level of protection ("Type").
- For conduit installations the conduit entry holes require standard opening to the required sizes specified per the NEC.
- Not intended for rigid conduit system.

Power Isolator Lock Off

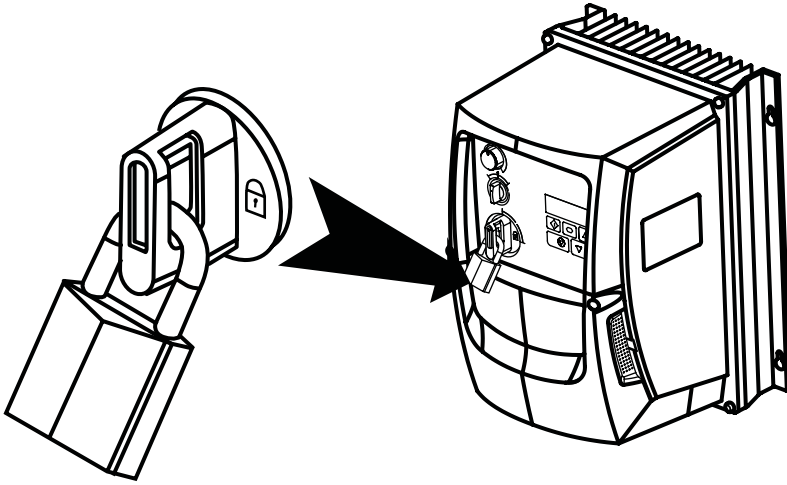

On the switched models the main power isolator switch can be locked in the 'Off' position using a 20mm standard shackle padlock (not supplied).

IP66 / Nema 4X Unit Lock Off



4. Electrical Installation

4.1. Connection Diagram

	This manual is intended as a guide for proper installation. Invertek Drives Ltd cannot assume responsibility for the compliance or the non-compliance to any code, national, local or otherwise, for the proper installation of this drive or associated equipment. A hazard of personal injury and/or equipment damage exists if codes are ignored during installation.
	This Optidrive contains high voltage capacitors that take time to discharge after removal of the main supply. Before working on the drive, ensure isolation of the main supply from line inputs. Wait ten (10) minutes for the capacitors to discharge to safe voltage levels. Failure to observe this precaution could result in severe bodily injury or loss of life.
	Only qualified electrical personnel familiar with the construction and operation of this equipment and the hazards involved should install, adjust, operate, or service this equipment. Read and understand this manual and other applicable manuals in their entirety before proceeding. Failure to observe this precaution could result in severe bodily injury or loss of life.

4.1.1. Grounding Guidelines

The ground terminal of each Optidrive should be individually connected DIRECTLY to the site ground bus bar (through the external EMC filter if one is installed). Optidrive ground connections should not loop from one drive to another, or to, or from any other equipment. Ground loop impedance must conform to local industrial safety regulations. To meet UL regulations, UL approved ring crimp terminals should be used for all ground wiring connections. The integrity of all ground connections should be checked periodically.

4.1.2. Protective Earth Conductor

The Cross sectional area of the PE Conductor must be at least equal to that of the incoming supply conductor.

4.1.3. Motor Ground

The motor ground must be connected to one of the ground terminals on the drive.

4.1.4. Ground Fault Monitoring

As with all inverters, a leakage current to earth can exist. The Optidrive is designed to produce the minimum possible leakage current whilst complying with worldwide standards. The level of current is affected by motor cable length and type, the effective switching frequency, the earth connections used and the type of RFI filter installed. If an ELCB (Earth Leakage Circuit Breaker) is to be used, the following conditions apply:

- A Type B Device must be used.
- The device must be suitable for protecting equipment with a DC component in the leakage current.
- The device must have a time delay to allow for charging currents on power up.
- Individual ELCBs should be used for each Optidrive.

Drives with an EMC filter have an inherently higher leakage current to Ground (Earth).

The Optidrive product range has input supply voltage surge suppression components fitted to protect the drive from line voltage transients, typically originating from lightning strikes or switching of high power equipment on the same supply.

4.1.5. Shield Termination (Cable Screen) – IP20 & IP66 Units

For best EMC performance and compliance with EMC directives when using enclosed drives, the power and motor cable shields should be connected to the cable shield / gland plate using a suitable EMC gland, ensuring direct metal to metal contact between the cable shield and the gland.

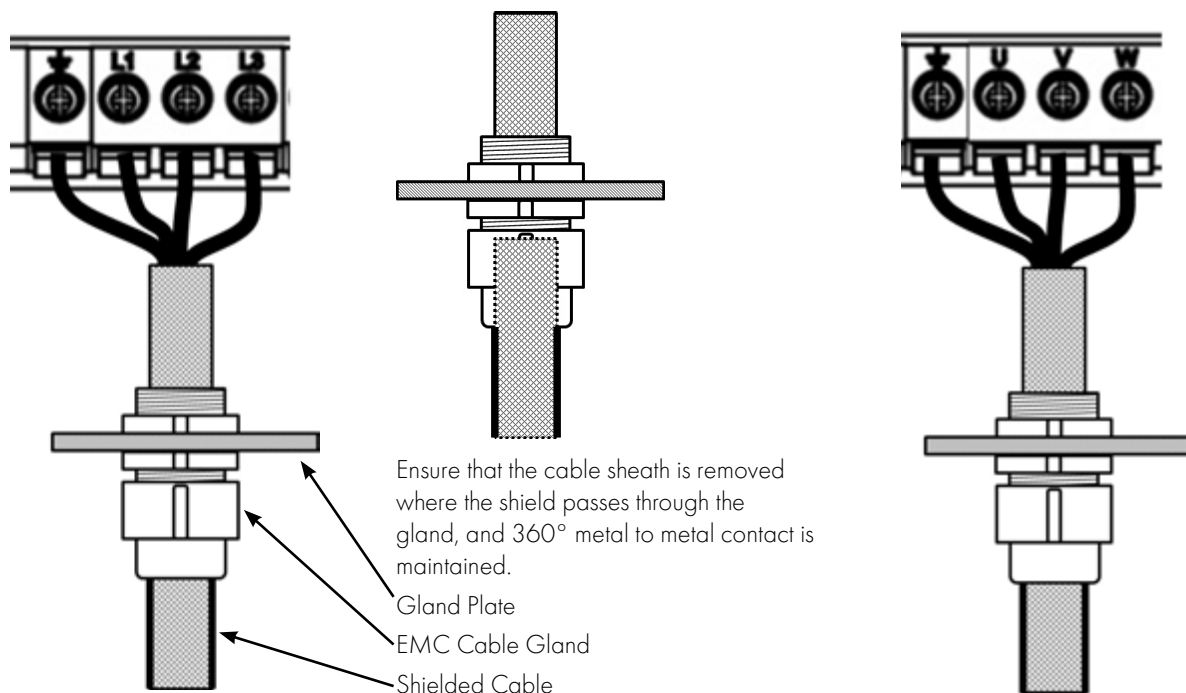

4.1.6. Shield Termination (Cable Screen) – IP55 Units

For best EMC performance and compliance with EMC directives when using enclosed drives, the power and motor cable shields should be connected to the cable shield / gland plate using a suitable EMC gland, ensuring direct metal to metal contact between the cable shield and the gland.

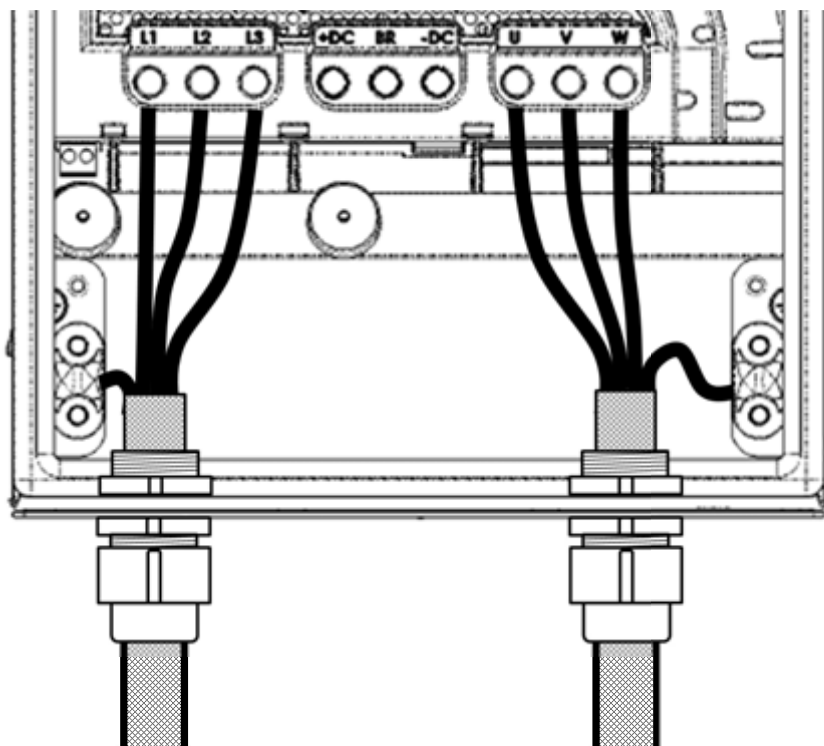

4.1.7. Recommended Installation for EMC Compliance – Panel Mount Units

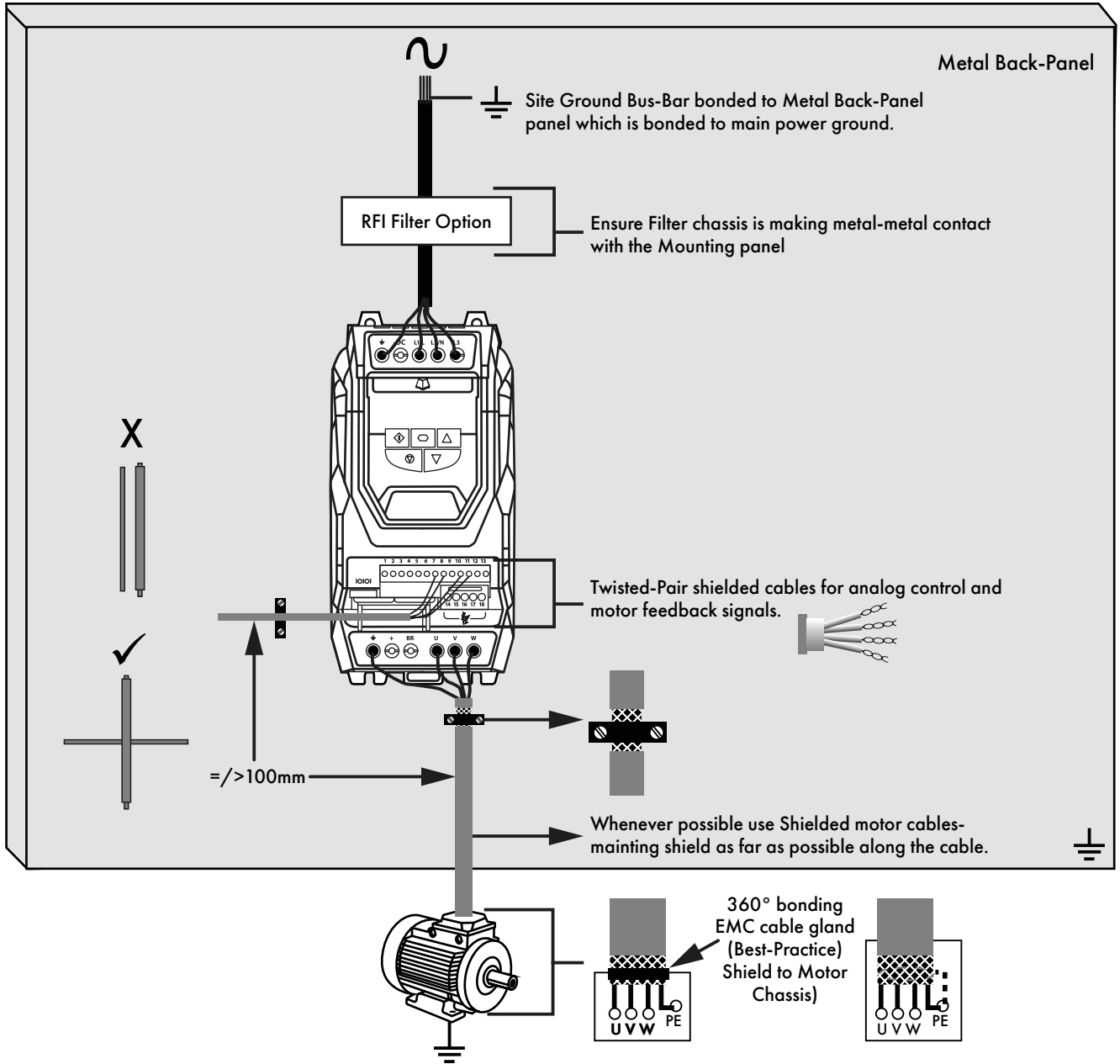

4.1.8. Wiring Precautions

Connect the Optidrive according to section 4.8. Control Terminal Wiring, ensuring that motor terminal box connections are correct. There are two connections in general: Star and Delta. It is essential to ensure that the motor is connected in accordance with the voltage at which it will be operated. For more information, refer to section 4.4. Drive and Motor Connection.

It is recommended that the power cabling should be 4-core PVC-insulated screened cable, laid in accordance with local industrial regulations and codes of practice.

4.2. Incoming Power Connection

- Power should be connected to the L1 and L2 terminals for single phase drives, L1, L2 and L3 for three phase drives. Phase sequence is not important.
- For compliance with CE and C Tick EMC requirements, a symmetrical shielded cable is recommended.
- A fixed installation is required according to IEC61800-5-1.
- For units without an internal isolator / disconnect, a suitable disconnecting device installed between the Optidrive and the AC Power Source. The disconnecting device must conform to the local safety code / regulations (e.g. within Europe, EN60204-1, Safety of machinery).
- The cables should be dimensioned according to any local codes or regulations.
- Suitable fuses to provide wiring protection of the input power cable should be installed in the incoming supply line, according to the data in section 11.4. Output Power and Current ratings. The fuses must comply with any local codes or regulations in place. In general, type gG (IEC 60269) or UL type J, T or CC fuses are suitable; however in some cases type aR fuses may be required. The operating time of the fuses must be below 0.5 seconds.
- Where allowed by local regulations, suitably dimensioned type B MCB circuit breakers of equivalent rating may be utilised in place of fuses, providing that the clearing capacity is sufficient for the installation.
- When the power supply is removed from the drive, a minimum of 30 seconds should be allowed before re-applying the power. A minimum of 10 minutes should be allowed before removing the terminal covers or connection.
- The maximum permissible short circuit current at the Optidrive Power terminals as defined in IEC60439-1 is 100kA.

4.3. Optional Input Chokes

- The majority of the Optidrive Eco product range is based on a low harmonic solution using film capacitor technology to achieve compliance with EN 61000-3-12 without the need for any additional equipment. This standard specifies limits for harmonic currents for equipment connected to public low-voltage systems with input current > 16A and <= 75A per phase. It is important to understand which models from the product range are of the low harmonic technology which is detailed below.
- The Optidrive Eco three phase 200V (200-240V) input and three phase 400V (380-480V) input drives frame sizes 2 up to and including frame size 5 are a lower harmonic drive using film capacitor technology.
- In short, this means that the low harmonic drives do not require an input choke and should not have one installed – drives outside of the above frame sizes and supply voltage / number of phases, could benefit from the use of input chokes if further harmonic reduction is required.
- The low harmonic drives must NOT be used with input chokes. Please see section 2.1.4. Low Harmonic Variants for a description of which drives fall into the low harmonic category. Input chokes may be required on the standard (non-low harmonic) drives to reduce the harmonics generated or if the incoming supply impedance is low or the fault level / short circuit current is high.

Drive Supply	Drive Rating	IP20 AC Input Inductor	IP66 AC Input Inductor
230V 1 Phase Input	0.75kW	OPT-2-L1016-20	OPT-2-L1016-66
	1.5 - 2.2kW	OPT-2-L1025-20	OPT-2-L1025-66
400V 3 Phase Input	55 - 90kW	OPT-2-L3200-00	N/A
	110 - 160kW	OPT-2-L3300-00	
	200 - 250kW	OPT-L3500-00 (4%)	
		OPT-2L31500-00 (1%)	
600V 3 Phase	0.75 - 2.2kW	N/A	OPT-2-L3006-66
	4.0 - 5.5kW		OPT-2-L3010-66
	7.5 - 11kW		OPT-2-L3018-66

4.4. Drive and Motor Connection

- The drive inherently produces fast switching of the output voltage (PWM) to the motor compared to the mains supply, for motors which have been wound for operation with a variable speed drive then there is no preventative measures required, however if the quality of insulation is unknown then the motor manufacturer should be consulted and preventative measures may be required.
- The motor should be connected to the Optidrive U, V, and W terminals using a suitable 3 or 4 core cable. Where a 3 core cable is used, with the shield operating as an earth conductor, the shield must have a cross sectional area at least equal to the phase conductors when they are made from the same material. Where a 4 core cable is utilised, the earth conductor must be of at least equal cross sectional area and manufactured from the same material as the phase conductors.
- The motor earth must be connected to one of the Optidrive earth terminals.
- For compliance with the European EMC directive, a suitable screened (shielded) cable should be used. Braided or twisted type screened cable where the screen covers at least 85% of the cable surface area, designed with low impedance to HF signals are recommended as a minimum. Installation within a suitable steel or copper tube is generally also acceptable.
- The cable screen should be terminated at the motor end using an EMC type gland allowing connection to the motor body through the largest possible surface area.
- Where drives are mounted in a steel control panel enclosure, the cable screen may be terminated directly to the control panel using a suitable EMC clamp or gland, as close to the drive as possible.
- Automatic switchgear should not be installed between the drive output and the motor, opening and closing contacts in this circuit whilst the drive is energised will inevitably reduce the lifetime of the drive and could cause product failure. If an isolator is required to be placed between the drive and the motor in order to comply with local regulations, the device must not be operated when the drive is running.

4.5. Motor Terminal Box Connections

Most general purpose motors are wound for operation on two supply voltage. This will be indicated on the nameplate of the motor. The operational voltage is normally selected when installing the motor by selecting either STAR or DELTA connection. STAR always gives the higher of the two voltage ratings.

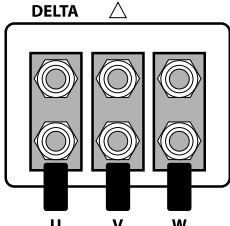
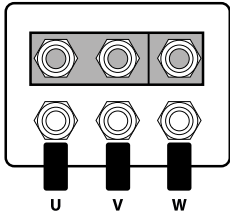
Incoming Supply Voltage	Motor Nameplate Voltages	Connection	
230	230 / 400	Delta	
400 / 460	400 / 690		
575	575 / 1000		
400	230 / 400	Star	
575	330 / 575		

4.6. Motor Thermal Overload Protection

4.6.1. Internal Thermal Overload Protection

Optidrive Eco has internal motor overload protection (current limit) set at 110% of FLA. This level may be adjusted in P4-07. The drive has an in-built motor thermal overload function; this is in the form of an "I.t-trP" trip after delivering >100% of the value set in P1-08 for a sustained period of time (e.g. 110% for 60 seconds).

4.6.2. Motor Thermistor Connection

Where a motor thermistor is to be used, it should be connected as follows:

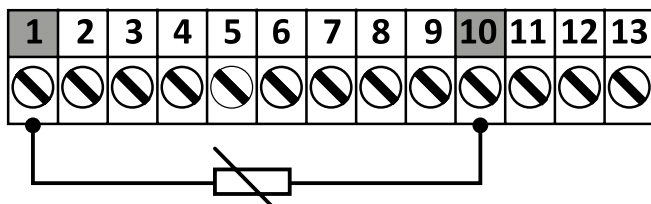
Control Terminals	Additional Information
	<ul style="list-style-type: none"> ▪ Compatible Thermistor: PTC Type, 2.5kΩ trip level. ▪ Use a setting of P1-13 that has Input 5 function as External Trip, e.g. P1-13 = 5. Refer to section 8.1. Digital Input Configuration Parameter P1-13 for further details. ▪ Enable Thermistor monitoring using P2-33 = Ptc-th.

4.7. EMC Compliant Installation

Rated Supply Voltage	Number of Input Phases	Frame Size	Effective Switching Frequency	Maximum Motor Cable Length to Achieve		
				C1 ^{1, 2, 5, 6, 8}	C2 ^{3, 5, 6, 8}	C3 ^{4, 7, 8}
230 V	1	2	4	1 m	5 m	25 m
230 V	3	2 - 5	16	1 m	5 m	25 m
230 V	3	6 - 7	4	-	-	25 m
400 V	3	2 - 5	16	1 m	5 m	25 m
400 V	3	6 - 8	4	-	-	25 m

The 500 – 600V drives are not intended for use in Europe and are designed without the internal filter built-in. External filters would be required with these models in order to achieve compliance with any given EMC standards.

Compliance with longer motor cable lengths can be achieved if the drive is used with an external EMC filter.

See notes below relating to the compliance in the above table.

General

¹ Compliance with category C1 conducted emissions only is achieved. For compliance with category C1 radiated emissions, additional measures may be required, contact your Sales Partner for further assistance.

Supply Cable

² A screened (shielded) cable suitable for fixed installation with the relevant mains voltage in use. Braided or twisted type screened cable where the screen covers at least 85% of the cable surface area, designed with low impedance to HF signals. Installation of a standard.

³ A cable suitable for fixed installation with relevant mains voltage with a concentric protection wire. Installation of a standard cable within a suitable steel or copper tube is also acceptable.

⁴ A cable suitable for fixed installation with relevant mains voltage. A shielded type cable is not necessary.

Motor Cable

⁵ A screened (shielded) cable suitable for fixed installation with the relevant mains voltage in use. Braided or twisted type screened cable where the screen covers at least 85% of the cable surface area, designed with low impedance to HF signals. Installation of a standard.

⁶ The cable screen should be terminated at the motor end using an EMC type gland allowing connection to the motor body through the largest possible surface area. Where drives are mounted in a steel control panel enclosure, the cable screen may be terminated directly to the control panel using a suitable EMC clamp or gland, as close to the drive as possible. For IP66 drives, connect the motor cable screen to the internal ground clamp.

⁷ A cable suitable for fixed installation with relevant mains voltage with a concentric protection wire. Installation of a standard cable within a suitable steel or copper tube is also acceptable.

Control Cable

⁸ A shielded cable with low impedance shield. Twisted pair cable is recommended for analog signals.

4.8. Control Terminal Wiring

- All analog signal cables should be suitably shielded. Twisted pair cables are recommended.
- Power and Control Signal cables should be routed separately where possible, and must not be routed parallel to each other.
- Signal levels of different voltages e.g. 24 Volt DC and 110 Volt AC, should not be routed in the same cable.
- Maximum control terminal tightening torque is 0.5Nm.
- Control Cable entry conductor size: 0.05 – 2.5mm² / 30 – 12 AWG.

4.9. Connection Diagram

4.9.1. Power Terminal Designations

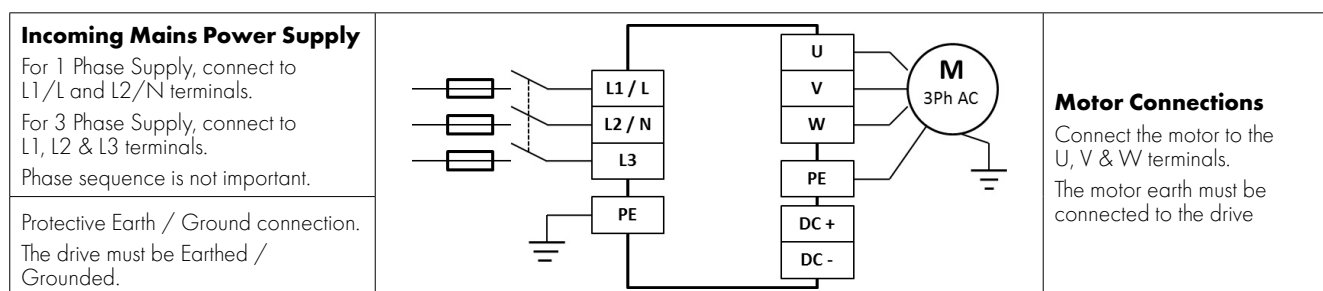

4.9.2. Control Terminal Connections & Factory Settings

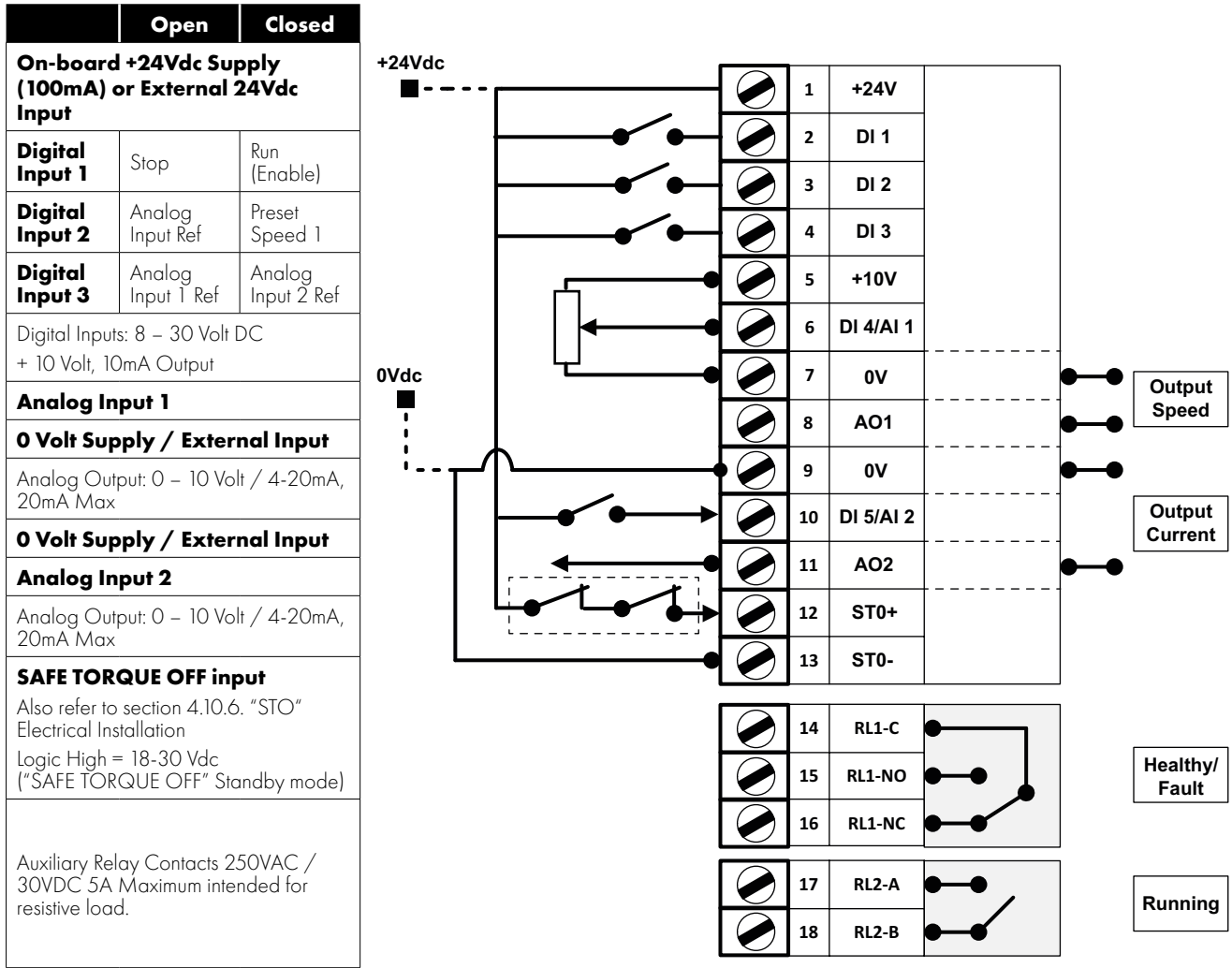

4.10. Safe Torque Off

Safe Torque Off will be referred to as "STO" through the remainder of this section.

4.10.1. Responsibilities

The overall system designer is responsible for defining the requirements of the overall "Safety Control System" within which the drive will be incorporated; furthermore the system designer is responsible for ensuring that the complete system is risk assessed and that the "Safety Control System" requirements have been entirely met and that the function is fully verified, this must include confirmation testing of the "STO" function before drive commissioning.

The system designer shall determine the possible risks and hazards within the system by carrying out a thorough risk and hazard analysis, the outcome of the analysis should provide an estimate of the possible hazards, furthermore determine the risk levels and identify any needs for risk reduction. The "STO" function should be evaluated to ensure it can sufficiently meet the risk level required.

4.10.2. What STO Provides

The purpose of the "STO" function is to provide a method of preventing the drive from creating torque in the motor in the absence of the "STO" input signals (Terminal 12 with respect to Terminal 13), this allows the drive to be incorporated into a complete safety control system where "STO" requirements need to be fulfilled.¹

The "STO" function can typically eliminate the need for electro-mechanical contactors with cross-checking auxiliary contacts as per normally required to provide safety functions.²

The drive has the "STO" Function built-in as standard and complies with the definition of "Safe torque off" as defined by IEC 61800-5-2:2007.

The "STO" Function also corresponds to an uncontrolled stop in accordance with category 0 (Emergency Off), of IEC 60204-1. This means that the motor will coast to a stop when the "STO" function is activated, this method of stopping should be confirmed as being acceptable to the system the motor is driving.

The “STO” function is recognised as a failsafe method even in the case where the “STO” signal is absent and a single fault within the drive has occurred, the drive has been proven in respect of this by meeting the following safety standards:

	SIL (Safety Integrity Level)	PFHD (Probability of dangerous Failures per Hour)	SFF (Safe failure fraction %)	Lifetime assumed
EN 61800-5-2	2	1.23E-09 1/h (0.12 % of SIL 2)	50	20 Yrs
	PL (Performance level)	CCF (%) (Common Cause Failure)		
EN ISO 13849-1	PL d	1		
	SILCL			
EN 62061	SILCL 2			

NOTE The values achieved above maybe jeopardised if the drive is installed outside of the Environmental limits detailed in section 11.1. Environmental.

	Disconnect and ISOLATE the drive before attempting any work on it. The “STO” function does not prevent high voltages from being present at the drive power terminals.
	¹ NOTE The “STO” function does not prevent the drive from an unexpected re-start. As soon as the “STO” inputs receive the relevant signal it is possible (subject to parameter settings) to restart automatically, Based on this, the function should not be used for carrying out short-term non-electrical machinery operations (such as cleaning or maintenance work).
	² NOTE In some applications additional measures may be required to fulfil the systems safety function needs: the “STO” function does not provide motor braking. In the case where motor braking is required a time delay safety relay and/or a mechanical brake arrangement or similar method should be adopted, consideration should be made over the required safety function when braking as the drive braking circuit alone cannot be relied upon as a fail safe method.
	When using permanent magnet motors and in the unlikely event of a multiple output power devices failing then the motor could effectively rotate the motor shaft by 180/p degrees (Where p denotes number of motor pole pairs).

4.10.3. “STO” Operation

When the “STO” inputs are energised, the “STO” function is in a standby state, if the drive is then given a “Start signal/command” (as per the start source method selected in P1-13) then the drive will start and operate normally.

When the “STO” inputs are de-energised then the STO Function is activated and stops the drive (Motor will coast), the drive is now in “Safe Torque Off” mode.

4.10.4. “STO” Status and Monitoring

There are a number of methods for monitoring the status of the “STO” input, these are detailed below:

Drive Display

In Normal drive operation (Mains AC power applied), when the drives “STO” input is de-energised (“STO” Function activated) the drive will highlight this by displaying “InHibit”, (**NOTE** If the drive is in a tripped condition then the relevant trip will be displayed and not “InHibit”).

Drive Output Relay

- Drive relay 1: Setting P2-15 to a value of “13” will result in relay opening when the “STO” function is activated.
- Drive relay 2: Setting P2-18 to a value of “13” will result in relay opening when the “STO” function is activated.

“STO” Fault Codes

Fault Code	Code Number	Description	Corrective Action
“Sto-F”	29	A fault has been detected within either of the internal channels of the “STO” circuit.	Refer to your Inverter Sales Partner

4.10.5. "STO" Function response time

The total response time is the time from a safety related event occurring to the components (sum of) within the system responding and becoming safe. (Stop Category 0 in accordance with IEC 60204-1).

- The response time from the "STO" inputs being de-energised to the output of the drive being in a state that will not produce torque in the motor ("STO" active) is less than 1ms.
- The response time from the "STO" inputs being de-energised to the "STO" monitoring status changing state is less than 20ms.
- The response time from the drive sensing a fault in the STO circuit to the drive displaying the fault on the display/Digital output showing drive not healthy is less than 20ms.

4.10.6. "STO" Electrical Installation



The "STO" wiring shall be protected from inadvertent short circuits or tampering which could lead to failure of the "STO" input signal, further guidance is given in the diagrams below.

In addition to the wiring guidelines for the "STO" circuit below, section 4.1.7. Recommended Installation for EMC Compliance – Panel Mount Units should also be followed.

The drive should be wired as illustrated below; the 24Vdc signal source applied to the "STO" input can be either from the 24Vdc on the drive or from an External 24Vdc power supply.

4.10.7. Recommended "STO" Wiring

Using an External 24Vdc Power Supply

Using the drives on-board 24Vdc supply

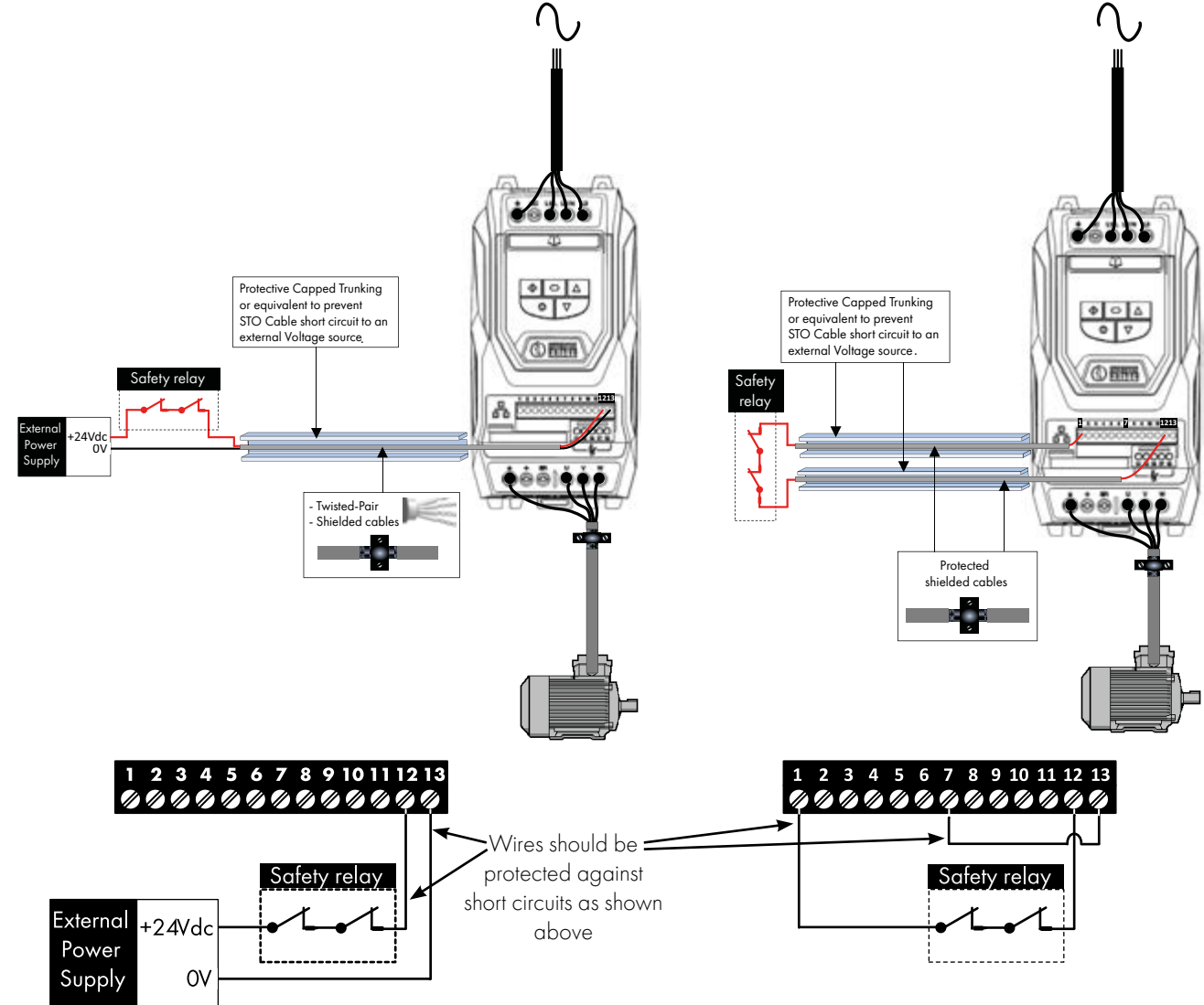

NOTE The Maximum cable length from Voltage source to the drive terminals should not exceed 25 metres.

4.10.8. External Power Supply Specification

Voltage Rating (Nominal)	24Vdc
STO Logic High	18-30Vdc (Safe torque off in standby)
Current Consumption (Maximum)	100mA

4.10.9. External Power Supply Specification

The safety relay should be chosen so that at minimum it meets the safety standards in which the drive meets.

Standard Requirements	SIL2 or PLd SC3 or better (With Forcibly guided Contacts)
Number of Output Contacts	2 independent
Switching Voltage Rating	30Vdc
Switching Current	100mA

4.10.10. Enabling the "STO" Function

The "STO" function is always enabled in the drive regardless of operating mode or parameter changes made by the user. In order to ensure that the drive does not immediately re-start when the STO is energised, the 'start mode' (P2-36) should be set to 'Edge-r' as opposed to the default value of 'Auto-0'. This means that when the drive is ready to run (STO active and drive healthy), it will only start when it sees a rising edge on the run command.

4.10.11. Testing the "STO" Function

Before commissioning the system the "STO" function should always be tested for correct operation, this should include the following tests:

- With the motor at standstill, and a stop command given to the drive (as per the start source method selected in P1-13):
 - De-energise the "STO" inputs (Drive will display "InHibit").
 - Give a start command (as per the start source method selected in P1-13) and check that the drive still displays "Inhibit" and that the operation is in line with the section 4.10.3. "STO" Operation and 4.10.4. "STO" Status and Monitoring.
- With the motor running normally (from the drive):
 - De-energise the "STO" inputs.
 - Check that the drive displays "InHibit" and that the motor stops and that the operation is in line with the section 4.10.3. "STO" Operation and 4.10.4. "STO" Status and Monitoring "STO" Function Maintenance.

The "STO" function should be included within the control systems scheduled maintenance program so that the function is regularly tested for integrity (Minimum once per year), furthermore the function should be integrity tested following any safety system modifications or maintenance work.

If drive fault messages are observed refer to section 12.1. Fault Messages for further guidance.

5. Keypad and Display Operation

The drive is configured and its operation monitored via the keypad and display.

5.1. OLED Keypad and Display Layout

OLED Display

Main Displayed Parameter
Shows which of the selectable parameters is currently being shown on the main display, e.g. Motor Speed, Motor Current etc.

Operating Information
Provides a real time display of key operating information, e.g. output current and power.

Start Button
When in Hand mode, used to Start the drive.

Stop / Reset Button
Used to reset a tripped drive.
When in Keypad mode, used to Stop the drive.

Hand Button
Used to place drive in Hand (keypad) mode.

Drive Address
Drive serial communication address set in parameter P5-01.

Control Keypad
Provides access to the drive parameters, and also allows control of the drive when Hand operation is selected.

Navigate Button
Used to display real-time information, to access and exit parameter edit mode and to store parameter changes.

Up Button
Used to increase speed in real-time mode or to increase parameter values in parameter edit mode.

Down Button
Used to decrease speed in real-time mode or to decrease parameter values in parameter edit mode.

Auto Button
Used to place drive in Auto (Remote) mode.

5.2. LED Keypad and Display Layout

	NAVIGATE	Used to display real-time information, to access and exit parameter edit mode and to store parameter changes.	
	UP	Used to increase speed in real-time mode or to increase parameter values in parameter edit mode.	
	DOWN	Used to decrease speed in real-time mode or to decrease parameter values in parameter edit mode.	
	RESET / STOP	Used to reset a tripped drive. When in Keypad mode is used to Stop a running drive.	
	START	When in keypad mode, used to Start a stopped drive or to reverse the direction of rotation if bi-directional keypad mode is enabled.	

5.3. Selecting the Language on the OLED Display

ECO	01	Select Language	Select Language
STOP		Español	Español
15kW 400V 3Ph		Deutsch	Deutsch
		English	English
Hold down the Start and Up keys for >1s	Use the Up and Down arrows to select a language.	Press the Navigate button to select.	

5.3.1. Operating Displays





Inhibit / STO Active	Drive Stopped	Drive Running Output Frequency Display	Drive Running Output Current Display	Drive Running Motor Power Display	Drive Running Motor Speed Display
LED Display :					
<i>INHIBIT</i>	<i>STOP</i>	<i>H 50.0</i>	<i>A 2.3</i>	<i>P 1.50</i>	<i>1500</i>
OLED Display :					
ECO 01 INHIBIT	ECO 01 STOP	Output Frequency 01 23.7Hz	Motor Current 01 15.3A	Motor Power 01 6.9kW	Motor Speed 01 718rpm
15kW 400V 3Ph	15kW 400V 3Ph	15.3A 6.9kW	6.9kW 23.7Hz	23.7Hz 15.3A	23.7Hz 15.3A
Drive Inhibited. The STO connections are not made. Refer to section 4.10.7. Recommended "STO" Wiring on page 26.	Drive Stopped / Disabled.	Drive is enabled / running, display shows the output frequency (Hz). Press the Navigate key to select alternative displays.	Press the Navigate key for < 1 second. The display will show the motor current (Amps).	Press the Navigate key for < 1 second. The display will show the motor power (kW).	If P-10 > 0, pressing the Navigate key for < 1 second will display the motor speed (Rpm).

5.4. Additional Display Messages

Auto Tuning in Progress	External 24VDC Supply	Overload	Fire Mode
LED Display :			
<i>Auto-t</i>	<i>Ext-24</i>	<i>H 50.0</i>	Not Indicated
OLED Display :			
Auto-tuning	ECO 01 Ext 24V	ECO 01 OL 23.7Hz	Fire Mode
	External 24V mode	15.3A 6.9kW	
Auto tune in progress. See parameter P4-02 information in section 9.3. Parameter Group 4 - High Performance Motor Control on page 43.	The drive control board is powered only from an external 24 Volt source, with no mains power applied.	Indicates an Overload condition. Output current exceeds the motor rated current entered in Parameter P1-08. LED display shows six flashing dots.	OLED display shows 'Fire Mode' flashing. LED shows no indication in display, but the fascia badge flashes.

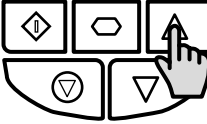
Switching Frequency Reduction	Mains Loss	Maintenance Time Elapsed
LED Display :		
Not Indicated	Not Indicated	Not Indicated
OLED Display :		
ECO 01 SF↓ 23.7Hz	ECO 01 ML 23.7Hz	ECO 01 ⚙️ 23.7Hz
15.3A	15.3A 6.9kW	15.3A 6.9kW
Switching frequency is reduced, due to high heatsink temperature.	The incoming mains power supply has been disconnected or is missing.	The user programmable maintenance reminder time has elapsed.

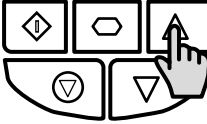
5.5. Changing Parameters

LED Display :					
StoP	P 1-01	P 1-08	A 2.3	P 1-08	StoP
OLED Display :					
Stop	ECO 01 P1-01	ECO 01 P1-08	ECO 01 30.0A ↕	ECO 01 P1-08	ECO 01 Stop
15kW 400V 3Ph	50.0Hz	30.0A	P1-08 ↑30.0 ↓3.0	30.0A	15kW 400V 3Ph
					
Press and hold the Navigate key > 2 seconds.	Use the up and down keys to select the required parameter. Drives with OLED display will show the present parameter value on the lower line of the display.	Press the Navigate key for < 1 second.	Adjust the value using the Up and Down keys. Drives with OLED display will show the maximum and minimum possible settings on the lower line of the display.	Press for < 1 second to return to the parameter menu.	Press for > 2 seconds to return to the operating display.

5.6. Parameter Factory Reset / User Reset

Optidrive P2 provides a feature to allow the user to define their own default parameter set. After commissioning all required parameters, the user can save these as the default parameters by setting P6-29 = 1. If required, the User Default Parameters may be cleared by setting P6-29 = 2.

If the user wishes to reload the User Default Parameters from the drive memory, the following procedure is used.

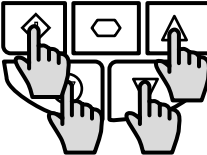
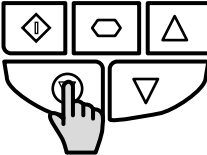
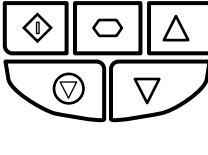
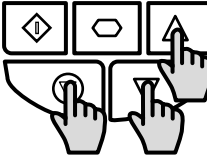
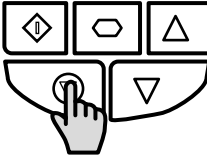
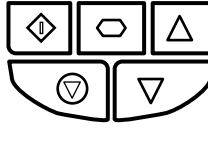
Factory Parameter Reset, LED Display :			User Parameter Reset, LED Display :		
StoP	P- dEF	StoP	StoP	U- dEF	StoP
Factory Parameter Reset, OLED Display :			User Parameter Reset, OLED Display :		
ECO 01 Stop	ECO 01 P-Def	ECO 01 Stop	ECO 01 Stop	ECO 01 U-Def	ECO 01 Stop
15kW 400V 3Ph	50.0Hz	15kW 400V 3Ph	P1-08 ↑30.0 ↓3.0	30.0A	15kW 400V 3Ph
					
Press and hold the Up, Down, Start and Stop keys for >2s.	The display shows P-de. Briefly press the Stop key.	The display returns to Stop. All parameters are reset to Factory defaults.	Press and hold the Up, Down and Stop keys for >2s.	The display shows U-def. Briefly press the Stop key.	The display returns to Stop. All parameters are reset to Factory defaults.

5.7. Resetting the Drive Following a Trip

Optidrive P2 has many protection features, designed to protect both the drive and motor from accidental damage. When any of these protection features are activated, the drive will trip, and display a fault message. The fault messages are listed in section 12.1. Fault Messages on page 65.

When a trip occurs, after the cause of the trip has been investigated and rectified, the user can reset the trip in one of the following ways:

- Press the keypad Stop key.
- Power off the drive completely, then power on again.
- If P1-13 > 0, switch off digital input 1, then back on again.
- If P1-12 = 4, reset via the fieldbus interface.
- If P1-12 = 6, reset via BACnet.

5.8. Selecting Between Hand and Auto Control

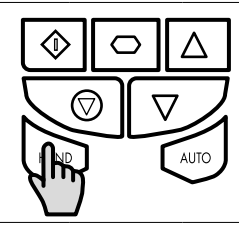
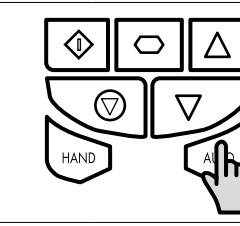
A Stop	H Stop
37kW 400V 3Ph	37kW 400V 3Ph
A = Auto	H = Hand
	
The active control source is shown on the OLED display. Use the Hand and Auto buttons on the keypad to switch between control sources.	Hand mode permits drive control directly from the drive keypad. Auto mode control source is configured with Parameter P1-12 (Control Mode)

NOTE The use of the Hand and Auto buttons can be disabled by adjusting the setting of P2-39 Parameter Access Lock

5.9. Keypad Short Cuts

The following short cuts can be used to speed up selecting and changing parameters when using the keypad.

5.9.1. Selecting the Parameter Groups

When extended or advanced parameter access is enabled (see section 9. Extended Parameters on page 36), additional parameter groups are visible, and may be selected quickly by the following method.

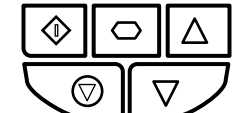
P1-01 	P2-01 
Whilst in the parameter selection menu, press the Navigate and Up or Navigate and Down keys simultaneously.	The next highest or lowest accessible parameter group will be selected.

5.9.2. Selecting the Lowest Parameter in a Group

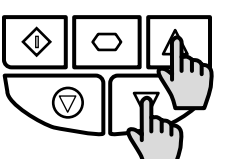
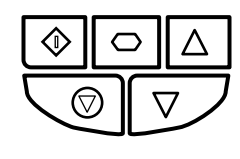
P1-08 	P1-01 
Whilst in the parameter selection menu, press the Up and Down keys simultaneously.	The next highest or lowest accessible parameter group will be selected.

5.9.3. Setting a Parameter to the Minimum Value

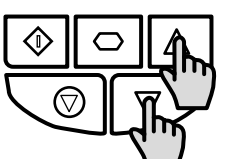
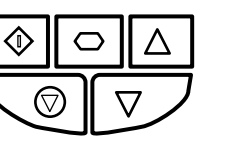
1500 	0 
Whilst editing a parameter value, press the Up and Down keys simultaneously.	The parameter will be set to the lowest possible value.

5.9.4. Adjusting Individual Digits

When editing parameter values and making large changes, e.g. setting the motor rated speed from 0 to 1500 Rpm, it is possible to directly select the parameter digits using the following method.

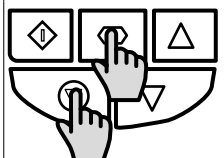
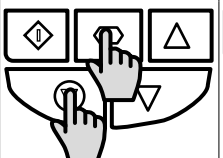
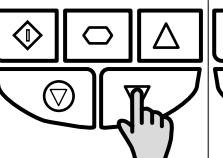
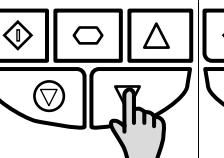
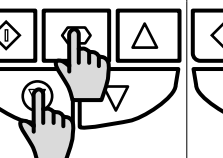
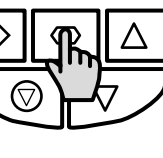
0 	_0 	_ 0 	100 	10_ 	P1-10 
Whilst editing a parameter value, press the Stop and Navigate keys simultaneously.	The cursor will step one digit to the left. Repeating the key press will move another digit to the left.	The individual digit value may be adjusted using the up and down keys.	Adjust the value using the Up and Down keys	When the cursor reaches the highest accessible digit, pressing Stop and Navigate will return the cursor to the right most digit.	Press the Navigate key to return to the parameter selection menu.

6. Commissioning

6.1. General

The following guidelines apply to all applications:

6.1.1. Entering the Motor Nameplate Information

Optidrive Eco uses the information from the motor nameplate to:

- Operate the motor with the best possible efficiency level.
- Protect the motor against possible damage due to operation in overload condition.

In order to achieve this, the Optidrive requires that the following information from the motor nameplate is entered into the parameters:

P1-07 Motor Rated Voltage. This is the operating voltage for the motor in its present wiring configuration (Star or Delta). The maximum output voltage from the Optidrive can never exceed the incoming supply voltage.

P1-08 Motor Rated Current. This is the full load current of the motor from the nameplate.

P1-09 Motor Rated Frequency. This is the standard operating frequency of the motor, generally 50 or 60Hz.

P1-10 Motor Rated Speed. This parameter can optionally be set to the Rpm shown on the motor nameplate. When this parameter is entered, all speed related parameters in the drive are displayed in Rpm. When the parameter is set to zero, all speed related parameters are displayed in Hz.

6.1.2. Minimum and Maximum Frequencies / Speeds

Optidrive Eco units are factory set to operate the motor from zero up to base speed (50 or 60Hz output). In general, this operating range is suitable for a wide range of requirements, however in some cases it may be desired to adjust these limits, e.g. where the maximum speed of a fan or pump may provide excessive flow, or where operation below a certain speed is never required. In this case, the following parameters can be adjusted to suit the application:

P1-01 Maximum Frequency. In general this should match the motor rated frequency. If operation above this frequency is desired, confirmation from the motor manufacturer, and the manufacturer of any connected fan or pump should be sought that this is permissible, and will not cause damage to the equipment.

P1-02 Minimum Frequency. A suitable minimum can be set to prevent the motor operating at low speed, which may cause the motor to overheat. In some applications, such as a pump circulating water through a boiler, it may be necessary to set a speed to ensure the boiler does not run dry during operation.

6.1.3. Acceleration and Deceleration Ramp Times

Optidrive Eco units are factory set with acceleration and deceleration ramp rates set to 30 seconds. The default value is suitable for the majority of applications but can be altered by changing the values in parameters P1-03 and P1-04. Care must be taken to ensure the driven load is capable of performing the specified ramps and that nuisance trips due to excessively short ramp times are not produced.

The ramp times entered in the parameter set always specify the time taken to ramp between 0Hz and motor rated speed P1-09.

For example: If ramp rate = 30 seconds and P1-09 (motor base speed) = 50Hz, and assuming the motor is currently running at 25Hz and the drive is commanded to accelerate to 50Hz. The time taken to reach 50Hz would be 30 seconds $(P1-03) / 50 (P1-09) * 25$ (required change in speed) = 15(s).

P1-03 Acceleration Ramp Rate: Time taken for the drive to accelerate the motor from 0Hz to Motor base speed, P1-09 in seconds.

P1-04 Deceleration Ramp Rate: Time taken for the drive to decelerate the motor from Motor base speed, P1-09 to 0Hz in seconds.

6.1.4. Stop Mode Selection

Optidrive Eco units can be programmed to either apply a fixed deceleration to the motor during stopping, or to release control of the motor and allow it to coast or free-wheel to a stop. The default selection is for the drive to ramp to stop and behaviour is programmed using parameter P1-05.

P1-05 Stop Mode Select: Defines how the motor will be stopped in the event of the enable input being removed from the drive. Ramp to stop (P1-05 = 0) will ramp the drive to stop using the value for deceleration entered in P1-04. Coast to stop (P1-05 = 1) will allow the motor to coast to stop (uncontrolled).

6.1.5. Voltage Boost

Voltage boost is used to increase the applied motor voltage at low output frequencies, in order to improve low speed and starting torque. Excessive boost levels may result in increased motor current and temperature, and force ventilation of the motor may be required.

The default value for Torque boost is set 0.0%, and this should only be increased if the starting torque is insufficient. Ensure that the correct Constant or Variable Torque mode is set in P4-01 before adjusting the boost.

P1-11 Torque Boost: Set as a percentage of motor rated voltage P1-07.

7. Parameters

7.1. Parameter Set Overview

The Optidrive Eco Extended Parameter set consists of 7 groups as follows:

- Group 1 – Basic Parameter Set
- Group 2 – Extended Parameter Set
- Group 3 – User PID Control Parameter Set
- Group 4 – Motor Control Parameters
- Group 5 – Field Bus Communications Parameter Set
- Group 8 – Application Specific Functions Parameter Set
- Group 0 – Monitoring and Diagnostic Parameters (Read Only).

When the Optidrive is reset to factory defaults, or is in its factory supplied state, only Group 1 Parameters can be accessed. In order to allow access to parameters from the higher level groups, P1-14 must be set to the same value as P2-40 (Default setting = 101). With this setting, parameter groups 1 – 5 and group 8 can be accessed, along with the first 39 parameters in Group 0. These parameters are listed in the tables below.

For advanced parameter access, P1-14 can be set to the same value as P6-30 (Default setting = 201), which allows access to all parameter groups and ranges. Advanced parameter descriptions are listed in the advanced user guide.

Values given in brackets () are default settings for horsepower rated drive models.

7.2. Parameter Group 1 – Basic Parameters

Par.	Parameter Name	Minimum	Maximum	Default	Units
P1-01	Maximum Speed Limit	P1-02	500.0	50.0 (60.0)	Hz / Rpm
	Maximum output frequency or motor speed limit – Hz or Rpm. If P1-10 >0, the value entered / displayed is in Rpm. NOTE The maximum possible setting of is limited to the lowest value of: <ul style="list-style-type: none"> ▪ 5 x P1-09 ▪ 5 x P1-10 ▪ P2-24 / 16 ▪ 500.0Hz 				
P1-02	Minimum Speed Limit	0.0	P1-01	0.0	Hz / Rpm
	Minimum speed limit – Hz or Rpm. If P1-10 >0, the value entered / displayed is in Rpm.				
P1-03	Acceleration Ramp Time	0.0	6000.0	30.0	Seconds
	Acceleration ramp time from 0 to base speed (P-1-09) in seconds.				
P1-04	Deceleration Ramp Time	0.0	6000.0	30.0	Seconds
	Deceleration ramp time from base speed (P1-09) to standstill in seconds.				
P1-05	Stop Mode Select	0	1	0	-
	0 Ramp To Stop	When the enable signal is removed, the drive will ramp to stop, with the rate controlled by P1-04 as described above.			
	1 Coast to Stop	When the enable signal is removed the motor will coast (freewheel) to stop.			
	2 AC Flux Braking	Provides additional braking torque capability when decelerating.			
P1-07	Motor Rated Voltage	0	Drive Rating Dependent	Volts	
	For Induction Motors - Enter the rated (nameplate) voltage of the motor (Volts). For PM & BLDC Motors - Enter the back EMF at rated motor speed.				
P1-08	Motor Rated Current	Drive Rating Dependent		100% drive rated current	Amps
	This parameter should be set to the rated (nameplate) current of the motor.				
P1-09	Motor Rated Frequency	25	500	50 (60)	Hz
	This parameter should be set to the rated (nameplate) current of the motor.				

Par.	Parameter Name	Minimum	Maximum	Default	Units
P1-10	Motor Rated Speed	0	30000	0	Rpm
	This parameter can optionally be set to the rated (nameplate) Rpm of the motor. When set to the default value of zero, all speed related parameters are displayed in Hz, and the slip compensation for the motor is disabled. Entering the value from the motor nameplate enables the slip compensation function, and the Optidrive display will now show motor speed in estimated Rpm. All speed related parameters, such as Minimum and Maximum Speed, Preset Speeds etc. will also be displayed in Rpm.				
P1-11	Torque Boost	0.0	0.0	Drive Rating Dependent	%
	<p>Torque Boost is used to increase the applied motor voltage and hence current at low output frequencies. This can improve low speed and starting torque. Increasing the boost level will increase motor current at low speed, which may result in the motor temperature rising - force ventilation of the motor may then be required. In general, the lower the motor power, the higher the boost setting that may be safely used.</p> <p>For IM motors, a suitable setting can usually be found by operating the motor under very low or no load conditions at approximately 5Hz, and adjusting P1-11 until the motor current is approximately the magnetising current.</p> <p>This parameter is also effective when using alternative motor types, P4-01 = 3, 4 or 5. In this case, the boost current level is defined as $4 \times P1-11 \times P1-08$.</p>				
P1-12	Control Mode Select	0	6	0	-
	0 Terminal Control	The drive responds directly to signals applied to the control terminals.			
	1 Uni-directional Keypad Control	The drive can be controlled in the forward direction only using an external or remote Keypad.			
	2 Uni-directional Keypad Control	As above.			
	3 PID Control	The output frequency is controlled by the internal PID controller.			
	4 Fieldbus Control	By the selected Fieldbus (Group 5 Parameters) – Excluded BACnet (see option 6).			
	5 Slave Mode	The drive acts as a Slave to a connected Optidrive operating in Master Mode.			
	6 BACnet Mode	Drive communicates / responds as a slave within a BACnet network.			
P1-13	Digital Input Function	0	14	1	-
	Defines the function of the digital inputs. When set to 0 the inputs are user defined using group 9 parameters or the PLC software function in the OptiTools Studio software package. When set to a value other than 0 the digital input configuration is defined by digital input definition table (see section 8.1. Digital Input Configuration Parameter P1-13).				
P1-14	Extended Menu Access Code	0	30000	0	-
	<p>Parameter Access Control. The following settings are applicable:</p> <p>P1-14 <> P2-40 and P1-14 <> P6-30: Allows access to Parameter Group 1 only.</p> <p>P1-14 = P2-40 (101 default): Allows access to Parameter Groups 0 - 5 and group 8.</p> <p>P1-14 = P6-30 (201 default): Allows access to Parameter Groups 0 - 9.</p>				

8. Control Terminal Functions

8.1. Digital Input Configuration Parameter P1-13

P1-13 ^{*(2)}	Local (Hand) Control Function	Digital Input 1 (Terminal 2)	Digital Input 2 (Terminal 3)	Digital Input 3 (Terminal 4)	Analog Input 1 (Terminal 6)	Analog Input 2 (Terminal 10)	Notes																																		
0	N/A	All functions User defined in Menu 9 or configured through PLC function in OptiTools studio software suite.																																							
1 ^{*(3)}	Analog Input 2	O: Stop C: Run/Enable	O: Normal Operation C: Preset 1/ PI Set-point 2	O: Remote Ctrl C: Local Ctrl	Analog In 1	Analog In 2	When Input 3 is Closed: Speed Reference = Analog Input 2 Start Command = Input 1 In PI Mode, Analog Input 1 must be used for feedback																																		
2		O: No Function C: Momentary Start	O: Stop (Disable) C: Run Permit	O: Remote Ctrl C: Local Ctrl	Analog In 1	Analog In 2																																			
3		O: Stop C: Run/Enable	O: Forward C: Reverse	O: Remote Ctrl C: Local Ctrl	Analog In 1	Analog In 2																																			
4		O: Stop C: Run/Enable	O: Fire Mode ^{*(1)} C: Normal Operation ^{*(1)}	O: Remote Ctrl C: Local Ctrl	Analog In 1	Analog In 2																																			
5	Preset Speeds	O: Stop C: Run/Enable	O: Preset Speed 1 C: Preset Speed 2	O: Remote Ctrl C: Local Ctrl	Analog In 1	O: Ext Trip C: Normal Operation	When Input 3 is Closed: Speed Reference = Preset Speed 1 / 2 Start Command = Input 1																																		
6		O: No Function C: Momentary Start	O: Stop (Disable) C: Run Permit	O: Remote Ctrl C: Local Ctrl	Analog In 1	O: Preset 1 C: Preset 2																																			
7		O: Stop C: Run/Enable	O: Forward C: Reverse	O: Remote Ctrl C: Local Ctrl	Analog In 1	O: Preset 1 C: Preset 2																																			
8		O: Stop C: Run/Enable	O: Fire Mode ^{*(1)} C: Normal Operation ^{*(1)}	O: Remote Ctrl C: Local Ctrl	Analog In 1	O: Preset 1 C: Preset 2																																			
9 ^{*(3)}	Keypad Speed Reference	O: Stop C: Run/Enable	O: Normal Operation C: Preset 1/ PI Set-point 2	O: Remote Ctrl C: Local Ctrl	Analog In 1	Analog In 2	When Input 3 is Closed: Speed Reference = Keypad Start Command = Determined by P2-37																																		
10 ^{*(3)}		O: Stop C: Run/Enable	O: Normal Operation C: Preset 1/ PI Set-point 2	O: Remote Ctrl C: Local Ctrl	Analog In 1	O: Ext Trip C: Normal Operation																																			
11		O: No Function C: Momentary Start	O: Stop (Disable) C: Run Permit	O: Remote Ctrl C: Local Ctrl	Analog In 1	Analog In 2																																			
12		O: Stop C: Run Fwd	O: Forward C: Reverse	O: Remote Ctrl C: Local Ctrl	Analog In 1	Analog In 2																																			
13		O: Stop C: Run Fwd	O: Fire Mode ^{*(1)} C: Normal Operation ^{*(1)}	O: Remote Ctrl C: Local Ctrl	Analog In 1	Analog In 2																																			
14	O: Stop C: Run	O: Forward C: Reverse		<table border="1"> <thead> <tr> <th>Digital input 3</th> <th>Analog input 1</th> <th>Analog input 2</th> <th>Preset Speed</th> </tr> </thead> <tbody> <tr><td>Off</td><td>Off</td><td>Off</td><td>Preset Speed 1</td></tr> <tr><td>On</td><td>Off</td><td>Off</td><td>Preset Speed 2</td></tr> <tr><td>Off</td><td>On</td><td>Off</td><td>Preset Speed 3</td></tr> <tr><td>On</td><td>On</td><td>Off</td><td>Preset Speed 4</td></tr> <tr><td>Off</td><td>Off</td><td>On</td><td>Preset Speed 5</td></tr> <tr><td>On</td><td>Off</td><td>On</td><td>Preset Speed 6</td></tr> <tr><td>Off</td><td>On</td><td>On</td><td>Preset Speed 7</td></tr> <tr><td>On</td><td>On</td><td>On</td><td>Preset Speed 8</td></tr> </tbody> </table>	Digital input 3	Analog input 1	Analog input 2	Preset Speed	Off	Off	Off	Preset Speed 1	On	Off	Off	Preset Speed 2	Off	On	Off	Preset Speed 3	On	On	Off	Preset Speed 4	Off	Off	On	Preset Speed 5	On	Off	On	Preset Speed 6	Off	On	On	Preset Speed 7	On	On	On	Preset Speed 8	
Digital input 3	Analog input 1	Analog input 2	Preset Speed																																						
Off	Off	Off	Preset Speed 1																																						
On	Off	Off	Preset Speed 2																																						
Off	On	Off	Preset Speed 3																																						
On	On	Off	Preset Speed 4																																						
Off	Off	On	Preset Speed 5																																						
On	Off	On	Preset Speed 6																																						
Off	On	On	Preset Speed 7																																						
On	On	On	Preset Speed 8																																						

Notes

^{*(1)}: Logic shown is as per the default setting. Fire mode logic can be configured through parameter P8-09.

^{*(2)}: Default setting for P1-13 = 1.

^{*(3)}: When the drive is in PID control (P1-12 = 3) and digital preset reference is selected (P3-05 = 0) then P1-13 can be set to 1, 9, or 10 to allow selection between two independent digital references using digital input 2. Digital preset reference 1 and 2 are set in P3-06 and P3-15 respectively.

NOTE "Motor thermistor trip" connection is via analog input 2 and is configured by parameter P2-33 (Ptc-Eh).

9. Extended Parameters

9.1. Parameter Group 2 – Extended parameters

Par	Parameter Name	Minimum	Maximum	Default	Units
P2-01	Preset Speed 1	-P1-01	P1-01	50.0 (60.0)	Hz / Rpm
P2-02	Preset Speed 2	-P1-01	P1-01	40.0	Hz / Rpm
P2-03	Preset Speed 3	-P1-01	P1-01	25.0	Hz / Rpm
P2-04	Preset Speed 4	-P1-01	P1-01	P1-01	Hz / Rpm
	Preset speeds can be selected by: <ul style="list-style-type: none"> ▪ Configuring P1-13 to an option that permits logic selection via the digital inputs (see section 8.1. Digital Input Configuration Parameter P1-13). ▪ Using the user defined logic configuration parameters in Parameter Group 9. ▪ Configured through the drive PLC function using the OptiTools Studio Suite PC software. 				
P2-05	Preset Speed 5 (Clean Speed 1)	-P1-01	P1-01	0.0	Hz / Rpm
	Preset speed 5 is automatically reference by the Pump Clean function when this is enabled. When the Pump Clean function is disabled, Preset speed 5 can be selected as per preset speeds 1 – 4.				
P2-06	Preset Speed 6 (Clean Speed 2)	-P1-01	P1-01	0.0	Hz / Rpm
	Preset speed 6 is automatically reference by the Pump Clean function when this is enabled. When the Pump Clean function is disabled, Preset speed 6 can be selected as per as per preset speeds 1 – 4.				
P2-07	Preset Speed 7 (Boost Speed 1 / Pump Stir Speed)	-P1-01	P1-01	0.0	Hz / Rpm
	Preset speed 7 is automatically referenced by the Start / Stop Boost function, or the Pump Stir Function, when these functions are enabled. When they are disabled, Preset speed 7 can be selected as per preset speeds 1 – 4.				
P2-08	Preset Speed 8 (Boost Speed 2)	-P1-01	P1-01	0.0	Hz / Rpm
	Preset speed 8 is automatically reference by the Start / Stop Boost function when this function is enabled. When disabled, Preset speed 8 can be selected as per preset speeds 1 – 4.				
P2-09	Skip Frequency Centre Point	P1-02	P1-01	0.0	Hz / Rpm
	Defines the centre point of the skip frequency band. The width of the skip frequency band is defined by: <ul style="list-style-type: none"> ▪ Lower limit = P2-09 - P2-10/2 ▪ Upper limit = P2-09 + P2-10/2 All skip frequency bands defined for forward speeds are mirrored for negative speeds.				
P2-10	Skip Frequency Band Width	0.0	P1-01	0.0	Hz / Rpm
	Defines the width of the skip frequency band. The width of the skip frequency band is defined by: <ul style="list-style-type: none"> ▪ Lower limit = P2-09 - P2-10/2 ▪ Upper limit = P2-09 + P2-10/2 All skip frequency bands defined for forward speeds are mirrored for negative speeds.				

Par	Parameter Name	Minimum	Maximum	Default	Units
P2-11	Analog Output 1 Function (Terminal 8)	0	12	8	-
	Digital Output Mode. Logic 1 = +24V DC				
Settings 4 to 7 use the adjustable limit parameters P2-16 and P2-17. The Output switches to Logic 1 (24 Volt DC) when the chosen analog value exceeds the Upper Threshold (P2-16) and resets to Logic 0 (0 Volt DC) when the chosen analog value reduces below the Lower Threshold (P2-17).					
0 : Drive Enabled (Running). Logic 1 when the Optidrive is enabled (Running).					
1 : Drive Healthy. Logic 1 when no Fault condition exists on the drive.					
2 : At Target Frequency (Speed). Logic 1 when the output frequency matches the setpoint frequency.					
3 : Output Frequency > 0.0. Logic 1 when the motor runs above zero speed.					
4 : Output Frequency >= Limit. Logic 1 when the motor speed exceeds the adjustable limit.					
5 : Output Current >= Limit. Logic 1 when the motor current exceeds the adjustable limit.					
6 : Output (Motor) Torque >= Limit. Logic 1 when the motor current exceeds the adjustable limit.					
7 : Analog Input 2 Signal Level >= Limit. Logic 1 when the signal applied to the Analog Input 2 exceeds the adjustable limit.					
Analog Output Mode (Format set in P2-12)					
8 : Output Frequency (Motor Speed). 0 to P-01.					
9 : Output (Motor) Current. 0 to 200% of P1-08.					
10 : Output (Motor) Torque. 0 to 165% of motor rated torque.					
11 : Output (Motor) Power. 0 to 150% of drive rated power.					
12 : PID Output. 0 to 100% represents the output of the internal PID controller.					
P2-12	Analog Output 1 Format (Terminal 8)	-	-	U 0-10	-
	U 0-10 = 0 to 10V U 10-0 = 10 to 0V A 0-20 = 0 to 20mA A 20-0 = 20 to 0mA A 4-20 = 4 to 20mA A 20-4 = 20 to 4mA				
P2-13	Analog Output 2 (Terminal 11) Function Select	0	12	9	-
	Digital Output Mode. Logic 1 = +24V DC				
Settings 4 to 7 use the adjustable limit parameters P2-19 and P2-20. The Output switches to Logic 1 (24 Volt DC) when the chosen analog value exceeds the Upper Threshold (P2-19) and resets to Logic 0 (0 Volt DC) when the chosen analog value reduces below the Lower Threshold (P2-20).					
0 : Drive Enabled (Running). Logic 1 when the Optidrive is enabled (Running).					
1 : Drive Healthy. Logic 1 When no Fault condition exists on the drive.					
2 : At Target Frequency (Speed). Logic 1 when the output frequency matches the setpoint frequency.					
3 : Output Frequency > 0.0. Logic 1 when the motor runs above zero speed.					
4 : Output Frequency >= Limit. Logic 1 when the motor speed exceeds the adjustable limit.					
5 : Output Current >= Limit. Logic 1 when the motor current exceeds the adjustable limit.					
6 : Motor Torque >= Limit. Logic 1 when the motor current exceeds the adjustable limit.					
7 : Analog Input 2 Signal Level >= Limit. Logic when the signal applied to the Analog Input 2 exceeds the adjustable limit.					
Analog Output Mode (Format set in P2-14)					
8 : Output Frequency (Motor Speed). 0 to P-01.					
9 : Output (Motor) Current. 0 to 200% of P1-08.					
10 : Motor Torque. 0 to 165% of motor rated torque.					
11 : Output (Motor) Power. 0 to 150% of drive rated power.					
12 : PID Output. 0 – 100% represents the output of the internal PID controller.					
P2-14	Analog Output 2 Format (Terminal 11)	-	-	U 0-10	-
	0-10 = 0 to 10V 0-0 = 10 to 0V A 0-20 = 0 to 20mA A 20-0 = 20 to 0mA A 4-20 = 4 to 20mA A 20-4 = 20 to 4mA				

Par	Parameter Name	Minimum	Maximum	Default	Units
P2-15	Relay Output 1 Function (Terminals 14, 15 & 16)	0	14	1	-
	Digital Output Mode. Logic 1 = +24V DC				
<p>Selects the function assigned to Relay Output 1. The relay has normally open and normally closed contacts. Logic 1 indicates the relay is active, and therefore the normally open contact is closed (terminals 14 and 15 will be linked together) and the normally closed contact is opened (terminals 14 and 16 will no longer be connected together).</p> <p>Settings 4, 5, 6, 7 & 14 use the adjustable limit parameters P2-16 and P2-17. The Output switches to Logic 1 (24 Volt DC) when the chosen analog value exceeds the Upper Threshold (P2-16) and resets to Logic 0 (0 Volt DC) when the chosen analog value reduces below the Lower Threshold (P2-17).</p> <p>0 : Drive Enabled (Running). Logic 1 when the motor is enabled.</p> <p>1 : Drive Healthy. Logic 1 when power is applied to the drive and no fault exists.</p> <p>2 : At Target Frequency (Speed). Logic 1 when the output frequency matches the set-point frequency.</p> <p>3 : Output Frequency > 0.0 Hz. Logic 1 when the drive output frequency to the motor exceeds 0.0Hz.</p> <p>4 : Output Frequency >= Limit. Logic 1 when the motor speed exceeds the adjustable limit.</p> <p>5 : Output Current >= Limit. Logic 1 when the motor current exceeds the adjustable limit.</p> <p>6 : Motor Torque >= Limit. Logic when the motor torque exceeds the adjustable limit.</p> <p>7 : Analog Input 2 Signal Level >= Limit. Logic 1 when the signal applied to the Analog Input 2 exceeds the adjustable limit.</p> <p>8 : Reserved. No Function.</p> <p>9 : Fire Mode Active. Logic 1 when the drive is running in Fire Mode (Fire Mode input is active).</p> <p>10 : Maintenance Due. Logic 1 when Maintenance Timer expires indicating that Maintenance is now due.</p> <p>11 : Drive Available. Logic 1 when drive is in Auto-mode, no trips are present, and the safety circuit is enabled indicating that drive is ready for automatic control.</p> <p>12 : Drive Tripped. Logic 1 when the drive has tripped and the display shows the fault code.</p> <p>13 : Hardware Inhibit Status. Logic 1 when both Hardware Enable (STO) inputs are present and the drive is able to be operated.</p> <p>14 : PID Error >= Limit. The PID Error (difference between setpoint and feedback) is greater than or equal to the programmed limit.</p> <p>15 : High/Low Load Detection Alarm. Logic 1 when the load monitoring has been enabled using P8-06 to P8-08 and a high load or low load condition has been detected – usually used to signal pump blockage or burst pipe.</p>					
P2-16	Adjustable Threshold 1 Upper Limit (AO1 / RO1)	P2-17	200.0	100.0	%
Setting the upper limited value for P2-11 and P2-15, please refer to P2-11 or P2-15.					
P2-17	Adjustable Threshold 1 Lower Limit (AO1 / RO1)	0	P2-16	0.0	%
Setting the lower limited value for P2-11 and P2-15, please refer to P2-11 or P2-15.					
P2-18	Relay Output 2 Function (Terminals 17 & 18)	0	14	0	-
	<p>Selects the function assigned to Relay Output 2. The relay has two output terminals, Logic 1 indicates the relay is active, and therefore terminals 17 and 18 will be linked together.</p> <p>Settings 4, 5, 6, 7 & 14 use the adjustable limit parameters P2-19 and P2-20. The Output switches to Logic 1 (24 Volt DC) when the chosen analog value exceeds the Upper Threshold (P2-19) and resets to Logic 0 (0 Volt DC) when the chosen analog value reduces below the Lower Threshold (P2-20).</p> <p>0 : Drive Enabled (Running). Logic 1 when the motor is enabled.</p> <p>1 : Drive Healthy. Logic 1 when power is applied to the drive and no fault exists.</p> <p>2 : At Target Frequency (Speed). Logic 1 when the output frequency matches the set-point frequency.</p> <p>3 : Output Frequency > 0.0 Hz. Logic 1 when the drive output frequency to the motor exceeds 0.0Hz.</p> <p>4 : Output Frequency >= Limit. Logic 1 when the motor speed exceeds the adjustable limit.</p> <p>5 : Output Current >= Limit. Logic 1 when the motor current exceeds the adjustable limit.</p> <p>6 : Output (Motor) Torque >= Limit. Logic 1 when the motor torque exceeds the adjustable limit.</p> <p>7 : Analog Input 2 Signal Level >= Limit. Logic 1 when the signal applied to the Analog Input 2 exceeds the adjustable limit.</p> <p>8 : Assist Pump 1 Control (DOL*). See section 7.1, Pump staging –DOL Cascade.</p> <p>9 : Fire Mode Active. Logic 1 when the drive is running in Fire Mode (Fire Mode input is active).</p> <p>10 : Maintenance Due. Logic 1 when Maintenance Timer expires indicating that Maintenance is now due.</p> <p>11 : Drive Available. Logic 1 when drive is in Auto-mode, no trips are present, and the safety circuit is enabled indicating that drive is ready for automatic control.</p> <p>12 : Drive Tripped. Logic 1 when the drive has tripped and the display shows the fault code.</p> <p>13 : Hardware Inhibit Status. Logic 1 when both Hardware Enable (STO) inputs are present and the drive is able to be operated.</p> <p>14 : PID Error >= Limit. The PID Error (difference between setpoint and feedback) is greater than or equal to the programmed limit.</p> <p>15 : High/Low Load Detection Alarm. Logic 1 when the load monitoring has been enabled using P8-06 to P8-08 and a high load or low load condition has been detected – usually used to signal pump blockage or burst pipe.</p>				
P2-19	Adjustable Threshold 2 Upper Limit (AO2 / RO2)	P2-20	200.0	100.0	%
Setting the upper limited value for P2-13 and P2-18, please refer to P2-13 or P2-18.					
P2-20	Adjustable Threshold 2 Lower Limit (AO2 / RO2)	0.0	P2-19	0.0	%
Setting the lower limited value for P2-13 and P2-18, please refer to P2-13 or P2-18.					

Par	Parameter Name	Minimum	Maximum	Default	Units
P2-21	Display Scaling Factor	-30.000	30.000	0.000	-
	Determines the factor for scaling display. The variable selected in P2-22 is scaled by the factor set in P2-21.				
P2-22	Display Scaling Source	0	3	0	-
	Source value used when custom units are to be shown on the drive display. 0 : Motor Speed 1 : Motor Current 2 : Analog Input 2 3 : P0-80 Selected Internal Value NOTE P2-21 & P2-22 allow the user to program the Optidrive display to show an alternative output unit scaled from an existing parameter (for example, to display conveyer speed in metres per second based on the output frequency). This function is disabled if P2-21 is set to 0. If P2-21 is set >0, the variable selected in P2-22 is multiplied by the factor entered in P2-21, and is shown on the drive display whilst the drive is running.				
P2-23	Zero Speed Holding Time	0.0	60.0	0.2	Seconds
	Determines the time for which the drive output frequency is held at zero when stopping, before the drive output is disabled.				
P2-24	Effective Switching Frequency	Drive Rating Dependent			kHz
	Effective power stage switching frequency. Higher frequencies reduce audible noise from the motor, and improve the output current waveform, at the expense of increased drive losses. NOTE De-rating of the drive output current may be required when increasing P2-24 beyond the minimum setting. Refer to section 11.7.3. Derating for Switching Frequency for further information.				
P2-25	2nd Ramp Time (Fast Stop)	0.00	240.0	0.0	Seconds
	This parameter allows an alternative deceleration ramp down time to be programmed into the Optidrive. Fast Deceleration ramp is selected Automatically in the case of a mains power loss if P2-38 = 2. When ramp rate in P2-25 is set to 0.0, the drive will coast to stop. Fast deceleration ramp can also be selected using the user defined logic configuration parameters in menu 9 (P9-02), or selection configured through the drive PLC function using the OptiTools Studio Suite PC software. In addition, if P2-25 > 0, P1-02 > 0, P2-10 = 0 and P2-09 = P1-02, this ramp time is applied to both acceleration and deceleration when operating below minimum speed, allowing selection of an alternative ramp when operating outside of the normal speed range, which may be useful in pump and compressor applications.				
P2-26	Spin Start Enable	0	2	1	-
	When Enabled, the drive will attempt to determine if the motor is already rotating on start up, and to detect rotational speed and direction. The drive will begin control of the motor from its present (detected) speed. A short delay may be observed when starting the drive whilst the spin start function is completed. 0 : Disabled 1 : Enabled 2 : Enabled following Trip, Brown Out or Coast Stop				
P2-27	Standby Mode Timer	0.0	250.0	0.0	Seconds
	This parameter defines the time period, whereby if the drive operates at the frequency / speed set in P3-14 (Standby speed threshold) for greater than the set time period, the Optidrive output will be disabled, and the display will show <i>Standby</i> . The function is disabled if P2-27 = 0.0.				
P2-28	Slave Speed Scaling Control	0	3	0	-
	Active in Keypad mode (P1-12 = 1 or 2) and Slave mode (P1-12=5) only. The keypad reference can be multiplied by a preset scaling factor or adjusted using an analog trim or offset. 0 : Disabled. No scaling or offset is applied. 1 : Actual Speed = Digital Speed x P2-29 2 : Actual Speed = (Digital Speed x P2-29) + Analog Input 1 Reference 3 : Actual Speed = (Digital Speed x P2-29) x Analog Input 1 Reference				
P2-29	Slave Speed Scaling Factor	-500.0	500.0	%	100.0
	Slave speed scaling factor used in conjunction with P2-28.				
P2-30	Analog Input 1 (Terminal 6) Format	See Below		U 0-10	-
	U 0-10 = 0 to 10 Volt Signal (Uni-polar). U 10-0 = 10 to 0 Volt Signal (Uni-polar). -10-10 = -10 to +10 Volt Signal (Bi-polar). A 0-20 = 0 to 20mA Signal. E 4-20 = 4 to 20mA Signal, the Optidrive will trip and show the fault code 4-20F if the signal level falls below 3mA. r 4-20 = 4 to 20mA Signal, the Optidrive will ramp to stop if the signal level falls below 3mA. E 20-4 = 20 to 4mA Signal, the Optidrive will trip and show the fault code 4-20F if the signal level falls below 3mA. r 20-4 = 20 to 4mA Signal, the Optidrive will ramp to stop if the signal level falls below 3mA.				

Par	Parameter Name	Minimum	Maximum	Default	Units
P2-31	Analog Input 1 Scaling	0.0	2000.0	100.0	%
	P2-31 is used to scale the analog input prior to being applied as a reference to the drive. For example, if P2-30 is set for 0 – 10V, and the scaling factor is set to 200.0%, a 5 volt input will result in the drive running at maximum speed (P1-01).				
P2-32	Analog Input 1 Offset	-500.0	500.0	0.0	%
	P2-32 defines an offset for the analog input, as a percentage of the full range of the input. A positive offset is deducted from the incoming analog signal and a negative offset is added to the signal. For example, if P2-30 is set for 0 – 10V, and the analog offset is set to 10.0%, then 1 volt (10% of 10V) will be deducted from the incoming analog reference prior to it being applied.				
P2-33	Analog Input 1 (Terminal 10) Format	See Below		U 0-10	-
	<p>U 0-10 = 0 to 10 Volt Signal (Uni-polar). U 10-0 = 10 to 0 Volt Signal (Uni-polar). Ptc-th = Motor PTC Thermistor Input. R 0-20 = 0 to 20mA Signal. E 4-20 = 4 to 20mA Signal, the Optidrive will trip and show the fault code 4-20F if the signal level falls below 3mA. r 4-20 = 4 to 20mA Signal, the Optidrive will ramp to stop if the signal level falls below 3mA. E 20-4 = 20 to 4mA Signal, the Optidrive will trip and show the fault code 4-20F if the signal level falls below 3mA. r 20-4 = 20 to 4mA Signal, the Optidrive will ramp to stop if the signal level falls below 3mA.</p>				
P2-34	Analog Input 2 Scaling	0.0	2000.0	100.0	%
	P2-34 is used to scale the analog input prior to being applied as a reference to the drive. For example, if P2-34 is set for 0 – 10V, and the scaling factor is set to 200.0%, a 5 volt input will result in the drive running at maximum speed (P1-01).				
P2-35	Analog Input 2 Offset	-500.0	500.0	0.0	%
	P2-35 defines an offset for the analog input, as a percentage of the full range of the input. A positive offset is deducted from the incoming analog signal and a negative offset is added to the signal. For example, if P2-33 is set for 0 – 10V, and the analog offset is set to 10.0%, then 1 volt (10% of 10V) will be deducted from the incoming analog reference prior to it being applied.				
P2-36	Start Mode Select / Automatic Restart	See Below		Auto-0	-
	<p>Defines the behaviour of the drive relating to the enable digital input and also configures the Automatic Restart function.</p> <p>Edge-r : Following Power on or reset, the drive will not start if Digital Input 1 remains closed. The Input must be closed after a power on or reset to start the drive.</p> <p>Auto-0 : Following a Power On or Reset, the drive will automatically start if Digital Input 1 is closed.</p> <p>Auto-1 to Auto-5 : Following a trip, the drive will make up to 5 attempts to restart at 20 second intervals. The drive must be powered down to reset the counter. The numbers of restart attempts are counted, and if the drive fails to start on the final attempt, the drive will fault with, and will require the user to manually reset the fault.</p> <p>⚠ DANGER! "Auto" modes allow the drive to Auto-start, therefore the impact on system/Personnel safety needs to be considered.</p>				
P2-37	Keypad / Fieldbus Starting Mode	0	7	2	-
	<p>Options 0 to 3 are only active when P1-12 = 1 or 2 (keypad Mode). With these settings, the drive waits for the keypad start button to be pressed before running.</p> <p>0 : Minimum Speed. Following a stop and restart, the drive will always initially run at the minimum speed P1-02.</p> <p>1 : Previous Operating Speed. Following a stop and restart, the drive will return to the last keypad set-point speed used prior to stopping.</p> <p>2 : Current Running Speed. Where the Optidrive is configured for multiple speed references (typically Hand / Auto control or Local / Remote control), when switched to keypad mode by a digital input, the drive will continue to operate at the last operating speed.</p> <p>3 : Preset Speed 4. Following a stop and restart, the Optidrive will always initially run at Preset Speed 4 (P2-04).</p> <p>Options 4 to 7 are only active in all control modes. Drive starting in these modes is controlled by the enable digital input on the control terminals.</p> <p>4 : Minimum Speed (Terminal Enable). Following a stop and restart, the drive will always initially run at the minimum speed P1-02.</p> <p>5 : Previous Operating Speed (Terminal Enable). Following a stop and restart, the drive will return to the last keypad set-point speed used prior to stopping.</p> <p>6 : Current Running Speed (Terminal Enable). Where the Optidrive is configured for multiple speed references (typically Hand / Auto control or Local / Remote control), when switched to keypad mode by a digital input, the drive will continue to operate at the last operating speed.</p> <p>7 : Preset Speed 4 (Terminal Enable). Following a stop and restart, the Optidrive will always initially run at Preset Speed 4 (P2-04).</p>				

Par	Parameter Name	Minimum	Maximum	Default	Units
P2-38	Mains Loss Stop Mode	0	2	0	-
<p>Controls the behaviour of the drive in response to a loss of mains power supply whilst the drive is enabled.</p> <p>0 : Mains Loss Ride Through. The Optidrive will attempt to continue operating by recovering energy from the load motor. Providing that the mains loss period is short, and sufficient energy can be recovered before the drive control electronics power off, the drive will automatically restart on return of mains power.</p> <p>1 : Coast To Stop. The Optidrive will immediately disable the output to the motor, allowing the load to coast or free wheel. When using this setting with high inertia loads, the Spin Start function (P2-26) may need to be enabled.</p> <p>2 : Fast Ramp To Stop. The drive will ramp to stop at the rate programmed in the Fast deceleration time P2-25.</p> <p>3 : Mains Loss Detection Disabled.</p>					
P2-39	Parameter Access Lock	0	1	0	-
<p>0 : Unlocked. All parameters can be accessed and changed</p> <p>1 : Locked. Parameter values can be displayed, but cannot be changed. Also disables Hand and Auto button on keypad.</p>					
P2-40	Extended Menu Access Code	0	9999	101	-
<p>Defines the access code which must be entered in P1-14 to access parameter groups above Group 1.</p>					

9.2. Parameter Group 3 – PID Control

Par	Parameter Name	Minimum	Maximum	Default	Units
P3-01	PID Proportional Gain	0.1	30.0	1.0	-
<p>PID Controller Proportional Gain. Instantaneous error between the feedback and the set-point in the PID controller is multiplied by P3-01 to produce the output from the PID controller. Higher values of proportional gain produce a larger change in the drive output frequency in response to changes in the PID set-point or feedback signals. Too high a value can cause instability.</p>					
P3-02	PID Integral Time	0.0	30.0	1.0	Seconds
<p>PID Controller Integral Time. Accumulated error in the PID control. Uses accumulated errors between set-point and feedback signals to influence the output from the PID controller. P3-02 is the time constant for accumulating error. Larger values provide a more damped response. Lower values result in a faster system response but may result in instability.</p>					
P3-03	PID Differential Time	0.00	1.00	0.00	Seconds
<p>PID Differential Time Constant. The Differential time constant references the rate of change of the feedback signal over time and works to slow the rate of change of the PID controller, particularly as it approached the set-point. Setting a shorter time will decrease overshoot but slow down response and may lead to instability.</p> <p>NOTE P3-03 is set to 0 by default which disables the differential time constant. Care must be taken when adjusting this value outside of its default value.</p>					
P3-04	PID Operating Mode	0	1	0	-
<p>0 : Direct Operation. Use this mode if an increase in the feedback signal should result in an decrease in the motor speed.</p> <p>1 : Inverse Operation. Use this mode if an increase in the feedback signal should result in an increase in the motor speed.</p>					
P3-05	PID Reference Select	0	2	0	-
<p>Selects the source for the PID Reference / Set-point</p> <p>0 : Digital Preset Set-point. P3-06 is used.</p> <p>1 : Analog Input 1 Set-point</p> <p>2 : Analog Input 2 Set-point</p>					
P3-06	PID Digital Reference Value	0.0	100.0	0.0	%
<p>When P3-05 = 0, this parameter sets the preset digital reference (set-point) used for the PID Controller.</p>					
P3-07	PID Output Upper Limit	P3-08	100.0	100.0	%
<p>Limits the maximum value output from the PID controller.</p>					
P3-08	PID Output Lower Limit	0.0	P3-07	0.0	%
<p>Limits the minimum output from the PID controller.</p>					
P3-09	PID Output Limit Control	0	3	0	-
<p>0 : Digital Output Limits. The output range of the PID controller is limited by the values of P3-07 & P3-08.</p> <p>1 : Analog Input 1 Provides a Variable Upper Limit. The output range of the PID controller is limited by the values of P3-08 & the signal applied to Analog Input 1.</p> <p>2 : Analog Input 1 Provides a Variable Lower Limit. The output range of the PID controller is limited by the signal applied to Analog Input 1 & the value of P3-07.</p> <p>3 : PID output Added to Analog Input 1 Value. The output value from the PID Controller is added to the speed reference applied to the Analog Input 1.</p>					

Par	Parameter Name	Minimum	Maximum	Default	Units
P3-10	PID Feedback Signal Source Select	0	5	0	-
	<p>Defines the source of the PID control feedback (location of the feedback sensor).</p> <p>0 : Analog Input 2. 0 – 100.0%.</p> <p>1 : Analog Input 1. 0 – 100.0%.</p> <p>2 : Motor current. 0 – 100.0% of P1-08 Value.</p> <p>3 : DC bus voltage. 0 – 1000 Volt = 0 – 100.0%.</p> <p>4 : Analog input 1 – Analog input 2. Differential of Analog 1 – Analog 2 = 0 – 100.0%.</p> <p>5 : Larger value between AnIn1 and AnIn2. The greater of Analog input 1 or Analog Input 2 is always used.</p>				
P3-11	PID Error to Enable Ramps	0.0	25.0	0.0	%
	<p>Defines a threshold PID error level, whereby if the difference between the set-point and feedback value is less than the set threshold, the internal ramp times of the drive are disabled to allow the drive to react quickly to small errors. Where a greater PID error exists, the ramp times are enabled to limit the rate of change of motor speed.</p> <p>Setting to 0.0 means that the drive ramps are always enabled. This parameter is intended to allow the user to disable the drive internal ramps where a fast reaction to the PID control is required, however by only disabling the ramps when a small PID error exists, the risk of possible over current or over voltage trips being generated are reduced.</p>				
P3-12	Feedback Display Scaling	0.000	50.000	0.000	-
	<p>Applies a scaling factor to the displayed PID feedback, allowing the user to display the actual signal level from a transducer, e.g. 0 – 10 Bar etc.</p>				
P3-13	PID Restart Error Level	0.0	100.0	5.0	%
	<p>Sets a programmable PID Error Level whereby if the drive enters standby mode whilst operating under PID control, the difference between the PID reference and PID feedback signals must exceed this error level to restart the PID controller.</p>				
P3-14	Standby Activation Speed	0.0	P1-01	0.0	Hz / Rpm
	<p>Determines the level at which the drive will enter into standby mode. P2-27 must be set with a value (time) for standby function to be active. Drive enters standby mode if motor speed remains below the level set in P3-14 for the time period set in P2-27.</p>				
P3-15	2nd PID Digital Reference Value	0.0	100.0	0.0	%
	<p>When P3-05 = 0, and the 2nd digital reference is selected (see section 8.1. Digital Input Configuration Parameter P1-13) this parameter sets the preset digital reference (set-point) used for the PID Controller.</p>				
P3-16	Pump Prime Time	0	600	0	Seconds
	<p>A value other than zero in this parameter will automatically enable the burst pipe detection function. Each time the drive is enabled whilst in PID control or is switched to PID control, the drive will monitor the PID feedback level for the time entered in P3-16. If the PID feedback level does not exceed the threshold entered in P3-17 before the time in P3-16 expires then the drive will trip with "Pr-Lo" (pressure low) trip.</p>				
P3-17	Burst Pipe Threshold	0.0	100.0	0.0	%
	<p>PID feedback threshold for the burst pipe detection. In direct PID mode, PID feedback should be equal to or greater than this threshold before the pump prime time (P3-16) expires. In inverse PID mode, PID feedback should be less than or equal to the threshold before the pump prime time (P3-16) expires.</p>				
P3-18	PID Operation Control	0	1	1	-
	<p>0 : Continuous Run. PID loop will continue running as long as P gain (P3-01) is not zero.</p> <p>1 : On drive Enable. PID loop will only run when the drive is enabled. If the drive is not running, PID output will reset to 0 (Including integral result).</p>				

9.3. Parameter Group 4 – High Performance Motor Control



Incorrect adjustment of parameters in menu group 4 can cause unexpected behaviour of the motor and any connected machinery. It is recommended that these parameters are only adjusted by experienced users.

Par	Parameter Name	Minimum	Maximum	Default	Units
P4-01	Motor Control Mode	0	6	0	-
	<p>0 : ECO Vector Speed Control (VT). Suitable for control of variable torque (centrifugal) fans and pumps with standard (IM) motors.</p> <p>1 : ECO Vector Speed Control (CT). Constant Torque, suitable for constant torque loads, such as displacement pumps with standard (IM) motors.</p> <p>2 : Vector Control (IM). Control mode for IM Motors.</p> <p>3 : ACPM Vector Control. Control mode for AC Permanent Magnet Motors.</p> <p>4 : BLDC Vector Control. Control mode for Brushless DC Motors.</p> <p>5 : SynRM Vector Control. Control mode for Synchronous Reluctance Motors.</p> <p>6 : LSPM Control. Control mode for Line Start Permanent Magnet Motors.</p> <p>NOTE Modes 0 and 1 do not require an autotune, although performance may be improved if one is carried out. Modes 2 and above require an autotune to be completed after the motor parameters are entered.</p>				
P4-02	Auto-tune Enable	0	1	0	-
	When set to 1, the drive immediately carries out a non-rotating auto-tune to measure the motor parameters for optimum control and efficiency. Following completion of the auto-tune, the parameter automatically returns to 0.				
P4-03	Vector Speed Controller Proportional Gain	0.1	400.0	50.0	%
	<p>Sets the proportional gain value for the speed controller. Higher values provide better output frequency regulation and response. Too high a value can cause instability or even over current trips. For applications requiring best possible performance, the value should be adjusted to suit the connected load by gradually increasing the value and monitoring the actual output speed of the load until the required dynamic behaviour is achieved with little or no overshoot where the output speed exceeds the setpoint.</p> <p>In general, the factory set value will be suitable for most fan and pump applications, higher friction loads can tolerate higher values of proportional gain, and high inertia, low friction loads may require the gain to be reduced.</p>				
P4-04	Vector Speed Controller Integral Time Constant	0.010	2.000	0.050	Seconds
	Sets the integral time for the speed controller. Smaller values provide a faster response in reaction to motor load changes, at the risk of introducing instability. For best dynamic performance, the value should be adjusted to suit the connected load.				
P4-05	Motor Power Factor Cos Ø	0.00	0.99	-	-
	When operating in Vector Speed motor control mode, this parameter must be set to the motor nameplate power factor.				
P4-07	Maximum Motoring Current / Torque Limit	0.0	150.0	110.0	%
	This parameter defines the maximum current or torque limit used by the drive.				
P4-12	Thermal Overload Value Retention	0	1	0	-
	<p>0 : Disabled.</p> <p>1 : Enabled. All Optidrive feature electronic thermal overload protection for the connected motor, designed to protect the motor against damage. An internal overload accumulator monitors the motor output current over time, and will trip the drive if the usage exceeds the thermal limit. When P4-12 is disabled, removing the power supply from the drive and re-applying will reset the value of the accumulator. When P4-12 is enabled, the value is retained during power off.</p>				
P4-13	Output Phase Sequence	0	1	0	-
	<p>0 : U,V,W.</p> <p>1 : U,W,V. Direction of motor rotation when operating in a forward direction will be reversed.</p>				
P4-14	Thermal Overload Limit Reaction	0	1	1	-
	<p>0 : It.trp. When the overload accumulator reaches the limit, the drive will trip on It.trp to prevent damage to the motor.</p> <p>1 : Current Limit Reduction. When the overload accumulator reaches 90% of, the output current limit is internally reduced to 100% of P-08 in order to avoid an It.trp. The current limit will return to the setting in P-54 when the overload accumulator reaches 10%.</p>				

9.4. Parameter Group 5 – Communication Parameters

Par	Name	Minimum	Maximum	Default	Units
P5-01	Drive Fieldbus Address	0	63	1	-
	Sets the Fieldbus address for the Optidrive. When using Modbus RTU, this parameter sets the Node Address. Refer to section 10.2. Modbus RTU Communications for further information. When Using BACnet MS/TP, this parameter sets the MAC ID. Refer to section 10.3. BACnet MSTP for further information.				
P5-03	Modbus RTU / BACnet MSTP Baud Rate	9.6	115.2	115.2	kbps
	Sets the baud rate when Modbus/BACnet communications are used. 9.6kbps, 19.2kbps, 38.4kbps, 57.6kbps, 115 kbps, 76.8kbps.				
P5-04	Modbus RTU / BACnet MSTP Data Format	-	-	n-1	-
	Sets the expected Modbus telegram data format as follows: n-1 : No Parity, 1 stop bit. n-2 : No parity, 2 stop bits. E-1 : Odd parity, 1 stop bit. E-1 : Even parity, 1 stop bit.				
P5-05	Communications Loss Timeout	0.0	5.0	1.0	Seconds
	Sets the watchdog time period for the communications channel. If a valid telegram is not received by the Optidrive within this time period, the drive will assume a loss of communications has occurred and react as selected below (P5-07).				
P5-06	Communications Loss Action	0	3	0	-
	Controls the behaviour of the drive following a loss of communications as determined by the above parameter setting (P5-06). 0 : Trip & Coast To Stop 1 : Ramp to Stop Then Trip 2 : Ramp to Stop Only (No Trip) 3 : Run at Preset Speed 4				
P5-07	Fieldbus Ramp Control	0	1	0	-
	Selects whether the acceleration and deceleration ramps are control directly via the Fieldbus, or by internal drive parameters P1-03 and P1-04. 0 : Disabled. Ramps are control from internal drive parameters. 1 : Enabled. Ramps are controlled directly by the Fieldbus.				
P5-08	Fieldbus Process Data Output Word 4 Select	0	7	1	-
	When using an optional Fieldbus interface, this parameter configures the parameter source for the 4th process data word transferred from the drive to the network master during cyclic communications: 0 : Output Torque. Output power in kW to one decimal place, e.g. 500 = 50.0%. 1 : Output Power. Output power in kW to two decimal places, e.g. 400 = 4.00kW. 2 : Digital Input Status. Bit 0 indicates digital input 1 status, bit 1 indicates digital input 2 status etc. 3 : Analog Input 2 Signal Level. 0 to 1000 = 0 to 100.0%. 4 : Drive Heat-sink Temperature. 0 to 100 = 0 to 100°C. 5 : User Register 1. Can be accessed by PLC program or group 9 parameters. 6 : User Register 2. Can be accessed by PLC program or group 9 parameters. 7 : PO-80 Value. PO-80 value can be selected by P6-28.				
P5-09	BACnet Device Instance Number (Low)	0	65535	0	-
P5-10	BACnet Device Instance Number (High)	0	63	0	-
	When using BACNet MS/TP, these parameter together allow a unique Device Instance Number to be programmed into the drive. For further information on using BACnet MS/TP, refer to section 10.3. BACnet MSTP.				
P5-11	BACnet Maximum Masters	0	127	127	-
	Parameter defines the maximum address of any BACnet masters that can exist on the current local MSTP BACnet network. Refer to section 10.3. BACnet MSTP for further information. When the device is polling for the next master in the network it will not poll about the value set in P5-11. For example, if the value is set to 50 then when the drive finishes communicating and needs to pass control to the next master it will poll up to address 50 looking for a response before rolling back to address 0.				

Par	Name	Minimum	Maximum	Default	Units
P5-12	Fieldbus Module PDO3	0	7	0	-
	<p>When using an optional Fieldbus interface, this parameter configures the parameter source for the 3rd process data word transferred from the drive to the network master during cyclic communications:</p> <p>0 : Motor Current. With one decimal place, e.g. 100.</p> <p>1 : Output Power. Output power in kW to two decimal places, e.g. 400 = 4.00kW.</p> <p>2 : Digital Input Status. Bit 0 indicates digital input 1 status, bit 1 indicates digital input 2 status etc.</p> <p>3 : Analog Input 2 Signal Level. 0 to 1000 = 0 to 100.0%.</p> <p>4 : Drive Heat-sink Temperature. 0 to 100 = 0 to 100°C.</p> <p>5 : User Register 1. Can be accessed by PLC program or group 9 parameters.</p> <p>6 : User Register 2. Can be accessed by PLC program or group 9 parameters.</p> <p>7 : P0-80 Value. P0-80 value can be selected by P6-28.</p>				
P5-13	Fieldbus Module PDI4	0	1	0	-
	<p>When using an optional Fieldbus interface, this parameter configures the parameter source for the 4th process data word transferred from the network master to the drive during cyclic communications:</p> <p>0 : User ramp time. In second with two decimal places.</p> <p>1 : User Register 4. Can be accessed by PLC program or group 9 parameters.</p>				
P5-14	Fieldbus Module PDI3	0	2	0	-
	<p>When using an optional Fieldbus interface, this parameter configures the parameter source for the 3rd process data word transferred from the network master to the drive during cyclic communications:</p> <p>0 : Not used. No function.</p> <p>1 : User PID Reference. 0 to 1000 = 0% to 100.0%.</p> <p>2 : User Register 3. Can be accessed by PLC program or group 9 parameters.</p>				
P5-15	Modbus Response Delay	0	16	0	Chr
	<p>Allows the user to configure an additional delay between the drive receiving a request via the Modbus RTU interface, and transmitting a reply. The value entered represents the delay in addition to the minimum delay permissible according to the Modbus RTU specification, and is expressed as the number of additional characters.</p>				

9.5. Parameter Group 8 – Application Function Specific Parameters

Par	Name	Minimum	Maximum	Default	Units
P8-01	Pump Stir Interval Duration	0	60000	0	Minutes
	This parameter can be used to set a pre-defined period of inactivity, whereby if the drive remains in standby mode for a period of time exceeding the limit, stir function is activated, and the drive will operate at preset speed 7 (P2-07) for the time set in P8-02. This allows the pump to stir, preventing sediment from settling and avoiding a blockage.				
P8-02	Pump Stir Activation Time	1	6000	10	Seconds
	Set the time period that the stir function will be active once triggered (excludes time for deceleration to stop).				
P8-03	Pump Clean Function Select	0	3	-	-
	<p>This parameter configures the drive conditions that will cause activation of the automatic pump clean function. When activated, the pump clean will operate the pump at preset speed 5 (P2-05) for the time period set in P8-04, followed by Preset Speed 6 (P2-06) (Providing P2-06 <> 0) for the time set in P8-04, before resuming normal operation. During the cleaning cycle, the ramp time set in P8-05 is used for both acceleration and deceleration, and overrides P1-03 and P1-04.</p> <p>Where possible, P2-05 and P2-06 may be set to negative values, to allow the pump to be reversed. For best results, it is recommended to use as high a speed as possible, and to adjust P8-05 to allow a short acceleration time whilst avoiding over current trips.</p> <p>0 : Disabled.</p> <p>1 : Active on start-up only. The pump cleaning function operates every time the pump is started.</p> <p>2 : Active on start-up and high current detection. The pump cleaning function operates every time the pump is started, and also in the event that the drive detects a possible pump blockage during normal operation. This requires the Motor Current Profile Monitoring function to be active and commissioned for correct operation, see parameter P8-06.</p> <p>3 : Active on high current detection only. The pump cleaning function operates only when a possible pump blockage is detected during normal operation. This requires the Motor Current Profile Monitoring function to be active and commissioned for correct operation, see parameter P8-06.</p> <p>NOTE The pump clean function can also be activated by digital input configured in group 9 parameters.</p>				
P8-04	Cleaning Time	0	600	0	Seconds
	Sets the time period for the operation of the pump cleaning cycle. When bi-directional pump cleaning is selected, the time interval is used twice, once in each direction.				
P8-05	Pump Clean Function Ramp Time	0	6000	30	Seconds
	Independent ramp rate used only for the pump automatic cleaning function (see P8-03) when the motor is Accelerated as part of the cleaning cycle.				
P8-06	Motor Current Profile Monitoring	0	4	0	-
	<p>This parameter enables the Total Motor Current Profile Monitoring Function, which can be used to detect belt failure in belt driven fan applications, or Dry Pump, Pump Blockage or broken impeller in Pump applications.</p> <p>0 : Disabled</p> <p>1 : Low Current Detection Enabled (Belt Failure / Dry Pump / Broken Impeller)</p> <p>2 : High Current Detection Enabled (Pump Blockage)</p> <p>3 : Low and High Current Detection</p> <p>4 : Low and High Current Detection, warning only. Bit 7 of the status word goes high in the event of a high or low current being detected but the drive will not trip.</p>				
	Adjustment of parameter P8-06 (<>0) will cause the drive to automatically run the motor through its programmed frequency range upon the next drive enable (input enable). Ensure the application is in a suitable condition to allow the motor to run safely through its frequency range prior to enabling this feature.				
P8-07	Motor Current Profile Bandwidth	0.1	50.0	1.0	Amps
	This parameter sets a bandwidth around the Motor Current profile generated by P8-06. If P8-06 has been set to an appropriate value to detect a high /low current condition and the drive operates outside of the bandwidth set in P8-07 for a period longer than that defined by P8-08 then the drive will trip. Value entered in P8-07 is the value between the normal current and the trip level, hence total bandwidth for the function is 2 x P8-07.				
P8-08	Motor Current Monitor Trip Delay	0	60	0	Seconds
	This parameter sets a time limit for the Motor Current profile generated by P8-06. If P8-06 has been set to an appropriate value to detect a high /low current condition and the drive operates outside of the bandwidth set in P8-07 for a period longer than that defined by P8-08 and then the drive will trip.				
P8-09	Fire Mode Logic	0	1	0	-
	<p>When Fire mode is assigned to a digital input on the drive then the logic configuration for the input is set by P8-09 to allow normally open or normally closed activation. Default behaviour is for Input logic off (0) to activate fire mode (Open activation).</p> <p>Input configuration for Fire mode is set by parameter P1-13 or can be user defined by the setting of P9-32.</p> <p>0 : Open Activation</p> <p>1 : Closed Activation</p>				

Par	Name	Minimum	Maximum	Default	Units
P8-10	Fire Mode Speed	-P1-01	P1-01	5	Hz / Rpm
	When set to a non-zero value, this parameter sets an operational fixed frequency / speed used when Fire Mode is selected. The drive will maintain operation at this frequency until the fire mode signal is removed or the drive is no longer able to sustain operation. When P8-10 is zero, and fire mode is activated, the drive will continue to operate under the control of the selected speed reference, dependent on parameter settings and digital input selection.				
P8-11	Bypass Mode on Fault	0	1	0	-
	Parameter configures the drive to switch to bypass mode automatically should a trip occur on the drive. When enabled the drive standard relays 1 and 2 are dedicated to bypass control and cannot be assigned other functions. 0 : Disabled 1 : Enabled				
P8-12	Bypass mode of Fire	0	1	0	-
	Parameter configures the drive to switch to bypass mode automatically should an input to the drive be configured for Fire Mode operation and that input becomes active. When enabled the drive standard relays 1 and 2 are dedicated to bypass control and cannot be assigned other functions. 0 : Disabled 1 : Enabled				
P8-13	Bypass Contactor Changeover Time	0	30	2	Seconds
	Parameter active when Bypass function is enabled. Parameter P8-05 sets a time delay or changeover time between the switching of the drive relays controlling the bypass circuitry.				
	Care must be taken when setting P8-13 to ensure that drive and DOL contactors are not switched in circuit simultaneously. Both Mechanical and Electrical interlocking of drive and DOL contactors to regional standards are recommended in configuring the Bypass function.				
P8-14	Pump Staging Function Select	0	2	0	-
	Parameter enables the pump staging (cascade) function on the drive. 0 : Disabled 1 : Single VFD with DOL Cascade (max 4 DOL pumps) 2 : Multiple Drive Cascade (Optiflow) Master Drive. (Only valid when drive set to Optibus master address, P5-01 = 1). 3 : Multiple Drive Cascade with Jockey Pump (Optiflow). Master Drive (Only valid when drive set to Optibus master address, P5-01 = 1) In this instance, the Master drive (with address P5-01 = 1) will remain active and will not be switched off to support the pump rotation ordinarily used for the purpose of sharing operating hours across all pumps. 4 : Multiple Drive Cascade Mode 2 (Optiflow) Master Drive. (Only valid when drive set to Optibus master address, P5-01 = 1) This mode is similar to mode 2 but the settling time works differently which can prevent multiple motors starting simultaneously when waking up from PID Standby mode. 5 : Multiple Drive Cascade with Jockey Pump Mode 2 (Optiflow) Master Drive. (Only valid when drive set to Optibus master address, P5-01 = 1) This mode is the same as mode 3 except that when an assist pump starts, the lead pump (jockey pump) will stop. When the assist pump goes into standby mode, the lead pump (jockey pump) will start again.				
P8-15	Number of Assist Pumps	1	4	1	-
	Parameter valid when P8-14 is set to 1 or 2 to enable Pump Staging Function. P8-15 set the number of assist pumps (P8-14 = 1) or network slave drives (P8-14 = 2) that are available in the Pump Staging application. Setting the value to 0 disables Pump Staging.				
P8-16	Pump Duty Switch Over Time	0	1000	0	Hours
	In order to balance run time (duty) on each pump in the Pump staging application and to ensure periodic operation of each pump P8-16 can be set with a time limit for pump switch over. When set to a value other than 0 (disabled) the operation of each staging pump will be cycled to ensure the difference in duty between each pump does not exceed the time set in P8-16.				
P8-17	Assist Pump Start Speed	P8-18	P1-01	49.0	Hz / Rpm
	This parameter defines the speed at which an "Assist" Pump is started when using the Pump Cascade or Optiflow feature. When the drive output increases beyond this threshold the next Staging pump is switch on. The Pump staging settle time must then expire before additional staging pumps can be brought on or off line. Priority for Staging pump switch on is always given to the pump with lowest run time accumulated.				
P8-18	Assist Pump Stop Speed	0	P8-17	30.0	Hz / Rpm
	This parameter defines the speed at which an "Assist" Pump is stopped when using the Pump Cascade or Optiflow feature. When the drive output decreases below this threshold one of the Staging pumps currently operating is switch off. The Pump staging settle time must then expire before additional staging pumps can be brought on or off line. Priority for Staging pump switch off is always given to the pump with highest run time accumulated.				
P8-19	Pump Settling Time	2	600	60	Seconds
	Parameter sets a time delay for pump staging whereby, following switch in or switch out of a staging pump, further pumps are not permitted to be switched in or out until this time period has elapsed. This parameter should be set to allow adequate settle time between staging pump transitions.				
P8-20	Pump Master Clock Reset	0	1	0	-
	Master drive in pump staging monitors and maintains duty run times for all available staging pumps. All clocks are available to view in PO-20. P8-20 provides the master reset to all run time clocks used for Pump Staging Function (all clocks set to 0).				

9.6. Parameter Group 0 – Monitoring Parameters (Read Only)

Par.	Parameter Name	Units
P0-01	Analog Input 1 Value	%
	Displays the signal level applied to analog input 1 (Terminal 6) after scaling and offsets have been applied.	
P0-02	Analog Input 2 Value	%
	Displays the signal level applied to analog input 2 (Terminal 10) after scaling and offsets have been applied.	
P0-03	Digital Input Status	Binary
	Displays the status of the drive inputs, including the extended I/O module (if fitted). 1st Entry: 00000 ... 11111. Drive digital Input status. MSB represents digital input 1 / LSB representing digital input 5. 2nd Entry: E 000 ... E 111. Drive Extended (option) Input status. MSB represents digital input 6 / LSB representing digital input 8.	
P0-04	Speed Controller Reference	Hz / Rpm
	Displays the set point reference input applied to the drive internal speed controller.	
P0-06	Digital Speed Reference	Hz / Rpm
	Displays the value of the drive internal Motorised Pot (used for keypad) speed reference.	
P0-07	Fieldbus Speed Reference	Hz / Rpm
	Displays the set-point being received by the drive from the currently active Fieldbus interface.	
P0-08	PID Reference	%
	Displays the set-point input to the PID controller.	
P0-09	PID Feedback	%
	Displays the Feedback input signal to the PID controller.	
P0-10	PID Output	%
	Displays the output level of the PID controller.	
P0-11	Motor Voltage	Volts
	Displays the instantaneous output voltage from the drive to the motor.	
P0-13	Trip Log	%
	Displays the last four fault codes for the drive. Refer to section 12.1. Fault Messages for further information.	
P0-14	Magnetising Current (Id)	Amps
	Displays the motor magnetising Current, providing an auto tune has been successfully completed.	
P0-16	DC Bus Voltage Ripple	Volts
	Displays the level of ripple present on the DC Bus Voltage. This parameter is used by the Optidrive for various internal protection and monitoring functions.	
P0-17	Stator Resistance (Rs)	Ohms
	Displays the measured motor stator resistance, providing an auto tune has been successfully completed.	
P0-19	Cascade Run Time Log	Hours
	Run Time values for variable speed and DOL pumps used in cascade function. 5 entry log. 0 = Master, 1 = DOL1, 2 = DOL2, 3 = DOL3, 4 = DOL4. Clocks can be reset through P8-20, Master Clock Reset.	
P0-20	DC Bus Voltage	Volts
	Displays the instantaneous DC Bus Voltage internally within the drive.	
P0-21	Drive Temperature	°C
	Displays the Instantaneous Heatsink Temperature measured by the drive.	
P0-22	Time Left to Next Service	Hours
	Displays the current time period remaining before the next maintenance becomes due. Maintenance interval is based on the value entered in P6-24 (Maintenance Time Interval) and the elapsed time since the maintenance interval was enabled or reset.	
P0-23	Time Heatsink >80° C	HH:MM:SS
	Two entry display: First display shows hours. Second display shows minutes and seconds. Displays the amount of time in hours and minutes that the Optidrive has operated for during its lifetime with a heatsink temperature in excess of 80°C. This parameter is used by the Optidrive for various internal protection and monitoring functions.	
P0-24	Time Ambient >80° C	HH:MM:SS
	Two entry display: First display shows hours. Second display shows minutes and seconds. Displays the amount of time in hours and minutes that the Optidrive has operated for during its lifetime with an ambient temperature in excess of 80°C. This parameter is used by the Optidrive for various internal protection and monitoring functions.	

Par.	Parameter Name	Units
P0-25	Estimated Rotor Speed	Hz
	Displays the estimated rotor speed of the motor.	
P0-26	kWh Meter	kWh
	Two entry display: First display shows user resettable meter (reset with P6-23). Second display shows none resettable value. Displays the amount of energy consumed by the drive in kWh. When the value reaches 1000, it is reset back to 0.0, and the value of P0-27 (MWh meter) is increased.	
P0-27	MWh Meter	MWh
	Two entry display: First display shows user resettable meter (reset with P6-23). Second display shows none resettable value. Displays the amount of energy consumed by the drive in MWh.	
P0-28	Software Version	-
	Displays the software version of the drive: Four entry display: First display = IO Version, Second display = IO Checksum, Third display = DSP Version, Fourth display = DSP Checksum	
P0-29	Drive Type	-
	Displays the type details of the drive: Three entry display: First display = Frame size and input voltage level. Second display = Power rating. Third display = Output Phase Count.	
P0-30	Serial Number	-
	Displays the unique serial number of the drive. Dual entry display: First display = Serial number (MSB), Second display = Serial number (LMSB).	
P0-31	Run Time Since Date of Manufacturer	HH:MM:SS
	Two entry display: First display shows hours. Second display shows minutes and seconds. Displays the total operating time of the drive.	
P0-32	Run Time Since Last Trip 1	HH:MM:SS
	Two entry display: First display shows hours. Second display shows minutes and seconds. Displays the total operating time of the drive since the last fault occurred. Run-time clock stopped by drive disable (or trip), reset on next enable only if a trip occurred. Reset also on next enable after a drive power down.	
P0-33	Run Time Since Last Trip 2	HH:MM:SS
	Two entry display: First display shows hours. Second display shows minutes and seconds. Displays the total operating time of the drive since the last fault occurred. Run-time clock stopped by drive disable (or trip), reset on next enable only if a trip occurred (under-volts not considered a trip) – not reset by power down / power up cycling unless a trip occurred prior to power down.	
P0-34	Run Time Since Last Disable	HH:MM:SS
	Two entry display: First display shows hours. Second display shows minutes and seconds. Displays the total operating time of the drive since the last Run command was received.	
P0-35	Fan Run Time	HH:MM:SS
	Displays the total operating time of the Optidrive internal cooling fans. Two entry display: First display shows user resettable time (reset with P6-22). Second display shows none resettable time. This is used for scheduled maintenance information.	
P0-36	DC Bus Voltage Log (256ms)	-
	Diagnostic log for DC bus voltage. Values logged every 256mS with 8 samples total. Logging suspended on drive trip.	
P0-37	DC Bus Voltage Ripple Log (20ms)	-
	Diagnostic log for DC bus voltage ripple. Values logged every 20mS with 8 samples total. Logging suspended on drive trip.	
P0-38	Heatsink Temperature Log (30s)	-
	Diagnostic log for heatsink temperature. Values logged every 30S with 8 samples total. Logging suspended on drive trip.	
P0-39	Ambient Temperature Log (30s)	-
	Diagnostic log for drive ambient temperature. Values logged every 30S with 8 samples total. Logging suspended on drive trip.	
P0-40	Motor Current Log (256ms)	-
	Diagnostic log for Motor Current. Values logged every 256mS with 8 samples total. Logging suspended on drive trip.	
NOTE The above parameters (P0-36 to P0-40) are used to store the history of various measured levels within the drive at various regular time intervals prior to a trip. The values are frozen when a fault occurs and can be used for diagnostic purposes.		

Par.	Parameter Name	Units
P0-41	Over Current Fault Counter	-
P0-42	Over Voltage Fault Counter	-
P0-43	Under Voltage Fault Counter	-
P0-44	Heatsink Over Temperature Fault Counter	-
P0-45	Brake Chopper Short Circuit Fault Counter	-
P0-46	Ambient Over Temperature Fault Counter	-
NOTE These parameters (P0-41 to P0-46) contain a record of how many times certain critical faults have occurred during a drives operating lifetime. This provides useful diagnostic data.		
P0-47	I/O comms fault counter	-
	Displays the number of communication errors detected by the I/O processor in messages received from the power stage processor since the last power up.	
P0-48	DSP comms fault counter	-
	Displays the number of communication errors detected by the Power Stage processor in messages received from the I/O processor since the last power up.	
P0-49	Modbus RTU / BACnet MSTP Fault Counter	-
	This parameter is incremented every time an error occurs on the Modbus RTU communication link. This information can be used for diagnostic purposes.	

10. Serial Communications

10.1. RS-485 Communications

Optidrive Eco has an RJ45 connector located within the wiring enclosure of the drive. This connector allows the user to set up a drive network via a wired connection. The connector contains two independent RS485 connections, one for Invertek’s Optibus Protocol and one for Modbus RTU / BACnet MSTP. Both connections can be used simultaneously.

The electrical signal arrangement of the RJ45 connector is shown as follows:

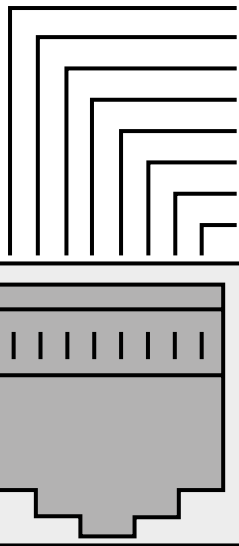
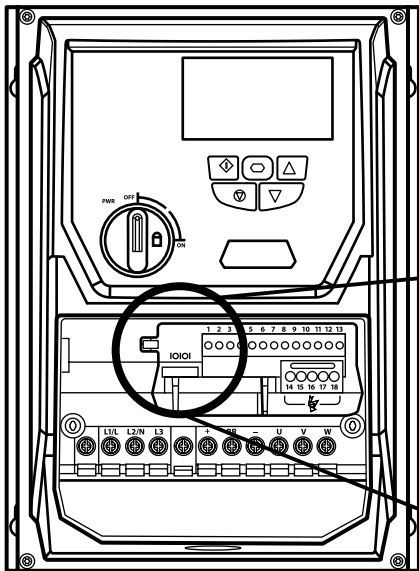

1	Not used
2	Not used
3	0 Volts
4	-RS485 (PC)
5	+RS485 (PC)
6	+24 Volt
7	RS 485- Modbus RTU / BACnet MSTP
8	RS 485+ Modbus RTU / BACnet MSTP
Warning: This is not an Ethernet connection. Do not connect directly to an Ethernet port.	
Warning: When using Modbus RTU or BACnet, ensure that the 0V signal (T3) is also used to avoid comms errors and potentially damaging common mode voltages.	

- The Optibus data link is only used for connection of Invertek peripherals and inter-drive communication.
- The Modbus interface allows connection to a Modbus RTU network as described in section 10.2. Modbus RTU Communications.

10.1.1. RS-485 Communications Electrical Connections

Modbus RTU and BACnet MSTP connection should be made via the RJ45 connector. The pin assignments are as shown in section 11.1. RS-485 communications.

- Modbus RTU and BACnet MSTP networks require three conductors for best operation and to eliminate common mode voltages on the drive terminals:
 - RSR85+
 - RS485-
 - 0 Volt Common
- Connection should be made using a suitable dual twisted pair, shielded cable, with a wave impedance of 120R.
- Use one of the twisted pairs to connect to the RS485+ and RS485- of each drive.
- Use one conductor of the remaining pair to connect together all the 0 volt common connection terminals.
- The cable shield should be connected to a suitable clean ground point to prevent interference with the screen maintained as close as possible to the cable terminations.
- Do not connect the 0 Volt Common, RS485- or RS485+ to ground at any point.
- Network terminating resistor (120R) should be used at the end of the network to reduce noise.

10.2. Modbus RTU Communications

10.2.1. Modbus Telegram Structure

The Optidrive Eco supports Master / Slave Modbus RTU communications, using the 03 Read Multiple Holding Registers and 06 Write Single Holding Register commands and 16 Write Multiple Holding Registers (Supported for registers 1 – 4 only). Many Master devices treat the first Register address as Register 0; therefore it may be necessary to convert the Register Numbers detail in section 11.2.2 by subtracting 1 to obtain the correct Register address.

10.2.2. Modbus Control & Monitoring Registers

The following is a list of accessible Modbus Registers available in the Optidrive Eco.

- When Modbus RTU is configured as the Fieldbus option, all of the listed registers can be accessed.
- Registers 1 and 2 can be used to control the drive providing that Modbus RTU is selected as the primary command source (P1-12 = 4) and no Fieldbus Option Module is installed in the drive Option Slot.
- Register 4 can be used to control the acceleration and deceleration rate of the drive providing that Fieldbus Ramp Control is enabled (P5-07 = 1).
- Registers 6 to 24 can be read regardless of the setting of P1-12.

Register Number	Upper Byte	Lower Byte	Read Write	Notes
1	Command Control Word		R/W	Command control word used to control the Optidrive when operating with Modbus RTU. The Control Word bit functions are as follows: Bit 0 : Run/Stop command. Set to 1 to enable the drive. Set to 0 to stop the drive. Bit 1 : Fast stop request. Set to 1 to enable drive to stop with 2nd deceleration ramp. Bit 2 : Reset request. Set to 1 in order to reset any active faults or trips on the drive. This bit must be reset to zero once the fault has been cleared. Bit 3 : Coast stop request. Set to 1 to issue a coast stop command.
2	Command Speed Reference		R/W	Setpoint must be sent to the drive in Hz to one decimal place, e.g. 500 = 50.0Hz.
3	Reserved		R/W	No Function.
4	Command Ramp times		R/W	This register specifies the drive acceleration and deceleration ramp times used when Fieldbus Ramp Control is selected (P5-08 = 1) irrespective of the setting of P1-12. The input data range is from 0 to 60000 (0.00s to 600.00s).
6	Error code	Drive status	R	This register contains 2 bytes. The Lower Byte contains an 8 bit drive status word as follows: Bit 0 : 0 = Drive Disabled (Stopped), 1 = Drive Enabled (Running). Bit 1 : 0 = Drive Healthy, 1 = Drive Tripped. Bit 2 : 0 = Auto, 1 = Hand. Bit 3 : Inhibit. Bit 4 : Service due. Bit 5 : Standby. Bit 6 : Drive Ready. Bit 7 : 0 = Normal condition, 1 = Low or High Load condition detected. The Upper Byte will contain the relevant fault number in the event of a drive trip. Refer to section 13.1 for a list of fault codes and diagnostic information.
7	Output Frequency		R	Output frequency of the drive to one decimal place, e.g.123 = 12.3 Hz.
8	Output Current		R	Output current of the drive to one decimal place, e.g.105 = 10.5 Amps.
9	Output Torque		R	Motor output torque level to one decimal place, e.g. 474 = 47.4 %.
10	Output Power		R	Output power of the drive to two decimal places, e.g.1100 = 11.00 kW.
11	Digital Input Status		R	Represents the status of the drive inputs where Bit 0 = Digital Input 1 etc.
20	Analog 1 Level		R	Analog Input 1 Applied Signal level in % to one decimal place, e.g. 1000 = 100.0%.
21	Analog 2 Level		R	Analog Input 2 Applied Signal level in % to one decimal place, e.g. 1000 = 100.0%.
22	Pre Ramp Speed Reference		R	Internal drive frequency set-point.

Register Number	Upper Byte	Lower Byte	Read Write	Notes
23	DC Link Voltage		R	Measured DC Link Voltage VDC (P0-20).
24	Drive Temperature		R	Measured Heatsink Temperature in °C (P0-21).
30	kWh Meter (User Resettable)		R	User resettable energy meter kWh (P0-26).
31	MWh Meter (User Resettable)		R	User resettable energy meter MWh (P0-27).
32	kWh Meter (Non Resettable)		R	Non resettable energy meter kWh (P0-26).
33	MWh Meter (Non Resettable)		R	Non resettable energy meter MWh (P0-27).
34	Running Time – Hours		R	Total running time (Hours) (P0-31).
35	Running Time – Min & Sec		R	Total Running Time (Minutes & Seconds) (P0-31).

10.2.3. Modbus Parameter Access

All User Adjustable parameters (Groups 1 to 5) are accessible by Modbus, except those that would directly affect the Modbus communications, e.g.

- P5-01 Drive Fieldbus Address.
- P5-03 Modbus RTU Baud Rate.
- P5-04 Modbus RTU Data Format.

All parameter values can be read from the drive and written to, depending on the operating mode of the drive – some parameters cannot be changed whilst the drive is enabled for example.

When accessing a drive parameter via Modbus, the Register number for the parameter is the same as the parameter number, e.g. Parameter P1-01 = Modbus Register 101.

Modbus RTU supports sixteen bit integer values, hence where a decimal point is used in the drive parameter, the register value will be multiplied by a factor of ten,

e.g. Read Value of P1-01 = 500, therefore this is 50.0Hz.

For further details on communicating with Optidrive using Modbus RTU, please refer to your local Invertek Sales Partner.

10.3. BACnet MSTP

10.3.1. Overview

Optidrive Eco provides an interface for direct connection to a BACnet MSTP network. Connection is made via the RJ45 connection port, see section 10.1. RS-485 Communications for terminal assignment and section 10.1.1. RS-485 Communications Electrical Connections for wiring requirements.

10.3.2. Interface Format

Protocol	:	BACnet MSTP
Physical signal	:	RS485, half duplex
Interface	:	RJ45
Baudrate	:	9600bps, 19200bps, 38400bps, 76800bps
Data format	:	8N1, 8N2, 8E1, 8O1

10.3.3. BACnet MSTP Parameters

The following parameters are used to configure the drive when connecting to a BACnet MSTP network.

Par.	Parameter Name	Description
P1-12	Control Source	Set this parameter to 6 to activate BACnet MSTP operation.
P5-01	Drive Address	This parameter is used to set the drive address on the BACnet network. Each drive on a given network should have a unique value. By default, all drives are set to MAC ID 1.
P5-03	Baudrate	This parameter is used to set up communication baudrate. It should be set to match the chosen baudrate of the BACnet system. Auto baudrate is not supported.
P5-04	Data Format	Use this parameter to set RS485 communication data format. Possible settings are as follows: n-1 : No parity, one stop bit (default setting) n-2 : No parity, two stop bits O-1 : Odd parity, one stop bit E-1 : Even parity, one stop bit The setting must match the requirement of the BACnet network.
P5-07	Fieldbus Ramp Control	This parameter determines whether the acceleration and deceleration time of the drive is controlled by the drive internal parameters (P1-03 : Acceleration Time, P1-04 : Deceleration Time), or controlled directly from the BACnet MSTP network. In most cases, using the drive internal parameters is the best solution.
P5-09	BACnet Device Instance ID Low	P5-09 and P5-10 are used to setup drive device instance ID value.
P5-10	BACnet Device Instance ID High	Instance ID = (P5-10 * 65536) + P5-09. The allowed setting range is Range from 0 ~ 4194304. Default value is set to 1.
P5-11	Max Master	Set BACnet MS/TP max master property, range from 1 ~ 127. Default set to 127.

10.3.4. BACnet MSTP Commissioning

In order to connect the drive and operate on a BACnet MSTP network, the following procedure should be used.

1. Set P1-14 = 101 to allow access to the extended parameters.
2. On each drive, set an unique Drive Address in parameter P5-01.
3. Set the required baudrate in P5-03.
4. Select the required data format in P5-04.
5. Define a unique BACnet Device Instance ID for each drive using parameters P5-09 and P5-10.
6. Select control from BACnet connection by setting P1-12 = 6.

10.3.5. Object Dictionary

Binary Value Object:

Binary Value Objects Table				
Instance ID	Object Name	Access	Description	Active/Inactive Text
BV0	Run/Stop State	R	This object indicates drive run status	RUN/STOP
BV1	Trip State	R	This object indicates if drive is tripped	TRIP/OK
BV2	Hand Mode	R	This object indicates if drive is in hand or auto mode	HAND/AUTO
BV3	Inhibit Mode	R	This object indicates drive is hardware inhibit	INHIBIT/OK
BV4	Mains Loss	R	This object indicates if mains loss happened	YES/NO
BV5	Fire Mode	R	This object indicates drive is in fire mode	ON/OFF
BV6	Enable State	R	This object indicates if drive has enable signal	YES/NO
BV7	External 24V Mode	R	This object indicates drive is in external 24V mode	YES/NO
BV8	Maintenance Due	R	This object indicates if maintenance service is due	YES/NO
BV9	Clean Mode	R	This object indicates if pump clean function is on	ON/OFF
BV10	Terminal Mode	R	This object indicates if drive is in terminal control mode	ON/OFF
BV11	Bypass Mode	R	This object indicate if drive is in bypass mode	ON/OFF
BV12	Digital Input 1	R	Status of digital input 1	ON/OFF
BV13	Digital Input 2	R	Status of digital input 2	ON/OFF
BV14	Digital Input 3	R	Status of digital input 3	ON/OFF
BV15	Digital Input 4	R	Status of digital input 4	ON/OFF
BV16	Digital Input 5	R	Status of digital input 5	ON/OFF
BV17	Digital Input 6	R	Status of digital input 6	ON/OFF
BV18	Digital Input 7	R	Status of digital input 7	ON/OFF
BV19	Digital Input 8	R	Status of digital input 8	ON/OFF
BV20	Relay Output 1	R	Status of relay output 1	CLOSED/OPEN
BV21	Relay Output 2	R	Status of relay output 2	CLOSED/OPEN
BV22	Relay Output 3	R	Status of relay output 3	CLOSED/OPEN
BV23	Relay Output 4	R	Status of relay output 4	CLOSED/OPEN
BV24	Relay Output 5	R	Status of relay output 5	CLOSED/OPEN
BV25	Run/Stop CMD	C	Drive run command object	RUN/STOP
BV26	Fast Stop	C	Fast stop enable object	ON/OFF
BV27	Trip Reset	C	Trip reset object (rising edge active)	ON/OFF
BV28	Coast Stop	C	Cost stop enable object (overrides fast stop)	ON/OFF
BV29*	Relay 1 CMD	C	User specified relay output 1 status	CLOSED/OPEN
BV30*	Relay 2 CMD	C	User specified relay output 2 status	CLOSED/OPEN
BV31*	Relay 3 CMD	C	User specified relay output 3 status	CLOSED/OPEN
BV32*	Relay 4 CMD	C	User specified relay output 4 status	CLOSED/OPEN
BV33*	Relay 5 CMD	C	User specified relay output 5 status	CLOSED/OPEN

* This function only works if the relay output can be controlled by user value (Refer to the Optidrive Eco Parameter List for further details)

Analog Value Object

Analog Value Objects Table				
Instance ID	Object Name	Access	Description	Units
AV0	Motor Frequency	R	Motor output frequency	Hertz
AV1	Motor Speed	R	Motor output speed (0 if P1 - 10=0)	Rpm
AV2	Motor Current	R	Motor output current	Amps
AV3	Motor Power	R	Motor output power	Kilowatts
AV4	Motor torque	R	Reserved	%
AV5	DC Bus Voltage	R	DC bus voltage	Volts
AV6	Drive temperature	R	Drive temperature value	°C
AV7	Drive Status	R	Drive status word	NONE
AV8	Trip Code	R	Drive trip code	NONE
AV9	Analog input 1	R	Value of analog input 1	Percent
AV10	Analog input 2	R	Value of analog input 2	Percent
AV11	Analog output 1	R	Value of analog output 1	Percent
AV12	Analog output 2	R	Value of analog output 2	Percent
AV13	PID Reference	R	PID controller reference value	Percent
AV14	PID feedback	R	PID controller feedback value	Percent
AV15	Speed Reference	C	Speed reference value object	Hertz
AV16	User Ramp Time	W	User ramp value	Seconds
AV17	User PID Reference	W	PID controller user reference	Percent
AV18	User PID Feedback	W	PID controller user feedback	Percent
AV19	Kilowatt Hours	R	Kilowatt hours (can be reset by user)	Kilowatt-hours
AV20	Megawatt Hours	R	Megawatt hours (can be reset by user)	Megawatt-hours
AV21	KWh meter	R	Kilowatt hours meter (cannot be reset)	Kilowatt-hours
AV22	MWh meter	R	Megawatt hours meter (cannot be reset)	Megawatt-hours
AV23	Total Run Hours	R	Total run hours since date of manufacture	Hours
AV24	Current Run Hours	R	Run hours since last time enable	Hours

* This function only works if the relay output can be controlled by user value (Refer to the Optidrive Eco Parameter List for further details)

10.3.6. Access type

R - Read only

W - Read or Write

C - Commandable

10.3.7. Supported Service

- WHO-IS (Reply with I-AM, and I-AM will also be broadcasted on power up and reset)
- WHO-HAS (Reply with I-HAVE)
- Read Property
- Write Property
- Device Communication Control
- Reinitialize Device

10.3.8. Object/Property Support Matrix

Property	Object Type		
	Device	Binary Value	Analog Value
Object Identifier	x	x	x
Object Name	x	x	x
Object Type	x	x	x
System Status	x		
Vendor Name	x		
Firmware Revision	x		
Application Software Revision	x		
Protocol Version	x		
Protocol Revision	x		
Protocol Services Supported	x		
Protocol Object Type Supported	x		
Object List	x		
Max APDU Length Accepted	x		
Segmentation Supported	x		
APDU Timeout	x		
Number of APDU Retries	x		
Max Master	x		
Max Info Frames	x		
Device Address Binding	x		
Database Revision	x		
Present Value		x	x
Status Flags		x	x
Event State		x	x
Out-of-Service		x	x
Units			x
Priority Array		x*	x*
Relinquish Default		x*	x*
Polarity		x	
Active Text		x	
Inactive Text		x	

* For commandable values only

10.3.9. BACnet Protocol Implementation Conformance Statement

Date:	15th April, 2015
Vendor Name:	Invertek Drives Ltd
Product Name:	OPTIDRIVE ECO
Product Model Number:	ODV-3-xxxxxx-xxxx-xx
Application Software Version:	2.00
Firmware Revision:	2.00
BACnet Protocol Revision:	7
Product Description:	Invertek Optidrive Eco

BACnet Standardized Device Profile (Annex L):

- BACnet Operator Workstation (B-OWS)
- BACnet Advanced Operator Workstation (B-AWS)
- BACnet Operator Display (B-OD)
- BACnet Building Controller (B-BC)
- BACnet Advanced Application Controller (B-AAC)
- BACnet Application Specific Controller (B-ASC)
- BACnet Smart Sensor (B-SS)
- BACnet Smart Actuator (B-SA)

List all BACnet Interoperability Building Blocks Supported (Annex K):

DS-RP-B, DS-WP-B, DM-DDB-B, DM-DOB-B, DM-DCC-B, DM-RD-B

Segmentation Capability:

- Able to transmit segmented messages Window Size
- Able to receive segmented messages Window Size

Standard Object Types Supported:

An object type is supported if it may be present in the device. For each standard Object Type supported provide the following data:

- 1) Whether objects of this type are dynamically creatable using the CreateObject service
- 2) Whether objects of this type are dynamically deletable using the DeleteObject service
- 3) List of the optional properties supported
- 4) List of all properties that are writable where not otherwise required by this standard
- 5) List of all properties that are conditionally writable where not otherwise required by this standard
- 6) List of proprietary properties and for each its property identifier, datatype, and meaning
- 7) List of any property range restrictions

Data Link Layer Options:

- BACnet IP, (Annex J)
- BACnet IP, (Annex J), Foreign Device
- ISO 8802-3, Ethernet (Clause 7)
- ATA 878.1, 2.5 Mb. ARCNET (Clause 8)
- ATA 878.1, EIA-485 ARCNET (Clause 8), baud rate(s):
- MS/TP master (Clause 9), baud rate(s): 9600, 19200, 38400, 76800
- MS/TP slave (Clause 9), baud rate(s):
- Point-To-Point, EIA 232 (Clause 10), baud rate(s):
- Point-To-Point, modem, (Clause 10), baud rate(s):
- LonTalk, (Clause 11), medium:
- BACnet/ZigBee (ANNEX O)
- Other:

Device Address Binding:

Is static device binding supported? (This is currently necessary for two-way communication with MS/TP slaves and certain other devices.)

- Yes No

Networking Options:

- Router, Clause 6 - List all routing configurations, e.g., ARCNET-Ethernet, Ethernet-MS/TP, etc.
- Annex H, BACnet Tunnelling Router over IP
- BACnet/IP Broadcast Management Device (BBMD)

Does the BBMD support registrations by Foreign Devices? Yes No

Does the BBMD support network address translation? Yes No

Network Security Options:

- Non-secure Device - is capable of operating without BACnet Network Security
- Secure Device - is capable of using BACnet Network Security (NS-SD BIBB)
- Multiple Application-Specific Keys:
- Supports encryption (NS-ED BIBB)
- Key Server (NS-KS BIBB)

Character Sets Supported:

Indicating support for multiple character sets does not imply that they can all be supported simultaneously.

- ANSI X3.4 IBM™/Microsoft™ DBCS ISO 8859-1
- ISO 10646 (UCS-2) ISO 10646 (UCS-4) JIS X 0208

If this product is a communication gateway, describe the types of non-BACnet equipment/networks(s) that the gateway supports.

11. Technical Data

11.1. Environmental

Ambient Temperature Range	Storage	All	-40 °C ... 60 °C
	Operational	IP20	-10 ... 50°C without derating
		IP55 IP66	-10 ... 40°C without derating
Maximum Altitude	Operational	All	1000m without derating
Relative Humidity	Operational	All	=< 95% (no condensation permitted)

Refer to section 11.7. Derating Information on page 64 for derating information.

11.2. Input Voltage Ranges

Depending upon model and power rating, the drives are designed for direct connection to the following supplies:

Model Number	Supply Voltage	Phases	Frequency
ODV-3-x2xxx-1xx-xx	200 – 240 Volts + / - 10%	1	50 – 60 Hz
ODV-3-x2xxx-3xx-xx	200 – 240 Volts + / - 10%	3	50 – 60 Hz
ODV-3-x4xxx-3xx-xx	380 – 480 Volts + / - 10%	3	50 – 60 Hz
ODV-3-x5xxx-3xx-xx	480 – 525 Volts + / - 10%	3	50 – 60 Hz
ODV-3-x6xxx-3xx-xx	500 – 600 Volts + / - 10%	3	50 – 60 Hz

11.3. Phase Imbalance

All three phase Optidrive Eco units have phase imbalance monitoring. The maximum permissible voltage imbalance between any two phases is 3% for full load operation.

11.4. Output Power and Current ratings

The following tables provide the output current rating information for the various Optidrive Eco models. Invertek Drives always recommend that selection of the correct Optidrive is based upon the motor full load current at the incoming supply voltage.

Please note that the maximum cable length stated in the following tables indicate the maximum permissible cable length for the drive hardware and does not take into consideration EMC compliance.

11.4.1. 200 – 240 Volt, 1 Phase Input Models

Frame Size	Output Current Capacity	Typical Power Rating		Nominal Input Current	Fuse or MCB (Type B)	Maximum Cable Size		Maximum Motor Cable Length	
	A	kW	HP	A		sq.mm	AWG	m	ft
2	4.3	0.75	1	8.5	10	8	4.3	100	330
2	7	1.5	2	15.2	25	8	7	100	330
2	10.5	2.2	3	19.3	25	8	10.5	100	330

11.4.2. 200 – 240 Volt, 3 Phase Input Models

Frame Size	Output Current Capacity	Typical Power Rating		Nominal Input Current	Fuse or MCB (Type B)	Maximum Cable Size		Maximum Motor Cable Length	
	A	kW	HP	A		sq.mm	AWG	m	ft
2	4.3	0.75	1	3.8	10	8	8	100	330
2	7	1.5	2	6.3	10	8	8	100	330
2	10.5	2.2	3	9.6	16	8	8	100	330
3	18	4	5	14	16	8	8	100	330
3	24	5.5	7.5	21.6	25	8	8	100	330
4	30	7.5	10	27	32	16	5	100	330
4	46	11	15	41.4	50	16	5	100	330
5	61	15	20	48.2	63	35	2	100	330
5	72	18.5	25	58	80	35	2	100	330
5	90	22	30	75.9	100	35	2	100	330
6	110	30	40	126.7	160	150	300MCM	100	330
6	150	37	50	172.7	200	150	300MCM	100	330
6	180	45	60	183.3	250	150	300MCM	100	330
7	202	55	75	205.7	250	150	300MCM	100	330
7	248	75	100	255.5	315	150	300MCM	100	330

11.4.3. 380 – 480 Volts, 3 Phase Input Models

Frame Size	Output Current Capacity	Typical Power Rating		Nominal Input Current	Fuse or MCB (Type B)	Maximum Cable Size		Maximum Motor Cable Length	
	A	kW	HP	A		sq.mm	AWG	m	ft
2	2.2	0.75	1	2	10	8	8	100	330
2	4.1	1.5	2	3.7	10	8	8	100	330
2	5.8	2.2	3	5.2	10	8	8	100	330
2	9.5	4	5	8.6	10	8	8	100	330
3	14	5.5	7.5	12.4	16	8	8	100	330
3	18	7.5	10	14	16	8	8	100	330
3	24	11	15	21.6	25	8	8	100	330
4	30	15	20	27	32	16	5	100	330
4	39	18.5	25	35.1	40	16	5	100	330
4	46	22	30	41.4	50	16	5	100	330
5	61	30	40	48.2	63	35	2	100	330
5	72	37	50	58	80	35	2	100	330
5	90	45	60	75.9	100	35	2	100	330
6	110	55	75	112.5	125	150	300MCM	100	330
6	150	75	100	153.2	200	150	300MCM	100	330
6	180	90	150	183.7	250	150	300MCM	100	330
7	202	110	175	205.9	250	150	300MCM	100	330
7	240	132	200	244.5	315	150	300MCM	100	330
7	302	160	250	307.8	400	150	300MCM	100	330
8	370	200	300	370	500	240	450MCM	100	330
8	450	250	350	450	500	240	450MCM	100	330

11.4.4. 500 – 600 Volt, 3 Phase Input Models

Frame Size	Output Current Capacity	Typical Power Rating		Nominal Input Current	Fuse or MCB (Type B)	Maximum Cable Size		Maximum Motor Cable Length	
	A	kW	HP	A		sq.mm	AWG	m	ft
2	2.1	0.75	1	2.5	10	8	8	100	330
2	3.1	1.5	2	3.7	10	8	8	100	330
2	4.1	2.2	3	4.9	10	8	8	100	330
2	6.5	4	5	7.8	10	8	8	100	330
2	9	5.5	7.5	10.8	16	8	8	100	330
3	12	7.5	10	14.4	16	8	8	100	330
3	17	11	15	20.6	25	8	8	100	330
3	22	15	20	26.7	32	8	8	100	330
4	22	15	20	26.7	32	16	5	100	330
4	28	18.5	25	34	40	16	5	100	330
4	34	22	30	41.2	50	16	5	100	330
4	43	30	40	49.5	63	16	5	100	330
5	54	37	50	62.2	80	35	2	100	330
5	65	45	60	75.8	100	35	2	100	330
6	78	55	75	90.9	125	150	300MCM	100	330
6	105	75	100	108.2	125	150	300MCM	100	330
6	130	90	125	127.7	160	150	300MCM	100	330
6	150	110	175	160	200	150	300MCM	100	330

NOTE

- The drive is protected against short-circuit from power output to protective earth for all rated cable lengths, cable sizes and cable types.
- The maximum motor cable length stated applies to using a shielded motor cable. When using an unshielded cable, the maximum cable length limit is increased by 50%. When using the Invertek Drives recommended output choke, the maximum cable length limited can be increased by 100%.
- The maximum cable lengths stated here are based on hardware limitations and do NOT take into consideration any requirements for compliance to any EMC standards. Please see section 4.7. EMC Compliant Installation for further information.
- The PWM output switching from any inverter when used with a long motor cable length can cause an increase in the voltage at the motor terminals, depending on the motor cable length and inductance. The rise time and peak voltage can affect the service life of the motor. Invertek Drives recommend using an output choke for motor cable lengths of 50m or more to ensure good motor service life.
- Supply and motor cable sizes should be dimensioned according to local codes or regulations in the country or area of installation.

11.5. Additional Information for UL Compliance

Optidrive Eco is designed to meet the UL requirements. For an up to date list of UL compliant products, please refer to UL listing NMMS.E226333. In order to ensure full compliance, the following must be fully observed.

Input Power Supply Requirements	
Supply Voltage	200 – 240 RMS Volts for 230 Volt rated units, + / - 10% variation allowed. 240 Volt RMS Maximum. 380 – 480 RMS Volts for 400 Volt rated units, + / - 10% variation allowed, Maximum 500 Volts RMS. 500 – 600 RMS Volts for 600 Volt rated units, + / - 10% variation allowed, Maximum 600 Volts RMS.
Imbalance	Maximum 3% voltage variation between phase – phase voltages allowed. All Optidrive Eco units have phase imbalance monitoring. A phase imbalance of > 3% will result in the drive tripping.
Frequency	50 – 60Hz + / - 5% Variation.
Short Circuit Capacity	All the drives in the Optidrive Eco range are suitable for use on a circuit capable of delivering not more than 100kA rms (AC) short-circuit Amperes symmetrical with the specified maximum supply voltage when protected by UL type J, T or CC fuses.

Mechanical Installation Requirements

All Optidrive Eco units are intended for indoor installation within controlled environments which meet the condition limits shown in section 11.1. Environmental.

The drive can be operated within an ambient temperature range as stated in section 11.1. Environmental.

For IP20 units, installation is required in a pollution degree 1 environment.

For IP66 (Nema 4X) units, installation in a pollution degree 2 environment is permissible.

Electrical Installation Requirements

Incoming power supply connection must be according to section 4.2. Incoming Power Connection.

Suitable Power and motor cables should be selected according to the data shown in section 11.4. Output Power and Current ratings and the National Electrical Code or other applicable local codes.

Motor Cable	75°C Copper must be used.
-------------	---------------------------

Power cable connections and tightening torques are shown in sections 3.5. Mounting the Drive – IP20 Units, 3.6. Guidelines for Mounting (IP66 Units) and 3.7. Guidelines for Mounting (IP55 Units).

Integral Solid State short circuit protection does not provide branch circuit protection. Branch circuit protection must be provided in accordance with the national electrical code and any additional local codes. Ratings are shown in section 11.4. Output Power and Current ratings.

For Installation in Canada.

Transient surge suppression must be installed on the line side of this equipment and shall be rated X Volt (phase to ground), X Volt (phase to phase), suitable for over voltage category iii and shall provide protection for a rated impulse withstand voltage peak of 2.5kV.

Where X is the supply voltage.

UL Listed ring terminals / lugs must be used for all bus bar and grounding connections.

General Requirements

Optidrive Eco provides motor overload protection in accordance with the National Electrical Code (US).

- Where a motor thermistor is not fitted, or not utilised, Thermal Overload Memory Retention must be enabled by setting P4-12 = 1.
- Where a motor thermistor is fitted and connected to the drive, connection must be carried out according to the information shown in section 9.3. Parameter Group 4 – High Performance Motor Control.

11.6. EMC Filter Disconnect

Drives with an EMC filter have an inherently higher leakage current to Ground (Earth). For applications where tripping occurs the EMC filter can be disconnected (on IP20 units only) by completely removing the EMC screw on the side of the product.

Remove the screw as indicated right.

The Optidrive product range has input supply voltage surge suppression components fitted to protect the drive from line voltage transients, typically originating from lightning strikes or switching of high power equipment on the same supply.

When carrying out a HiPot (Flash) test on an installation in which the drive is built, the voltage surge suppression components may cause the test to fail. To accommodate this type of system HiPot test, the voltage surge suppression components can be disconnected by removing the VAR screw. After completing the HiPot test, the screw should be replaced and the HiPot test repeated. The test should then fail, indicating that the voltage surge suppression components are once again in circuit.

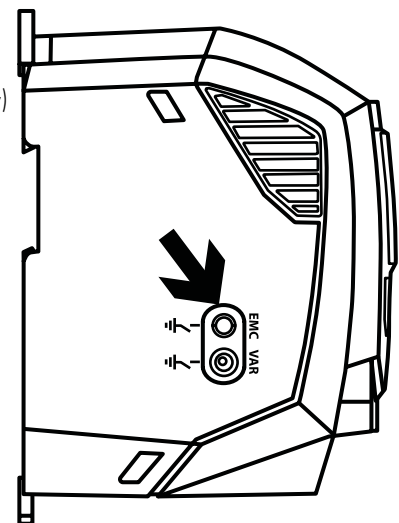

11.7. Derating Information

Derating of the drive maximum continuous output current capacity is require when:

- Operating at ambient temperature in excess of 40°C / 104°F (IP55 & IP66) or 50°C / 122°F (IP20).
- Operating at Altitude in excess of 1000m/ 3281 ft.
- Operation with Effective Switching Frequency higher than the minimum setting.

The following derating factors should be applied when operating drives outside of these conditions.

11.7.1. Derating for Ambient Temperature

Enclosure Type	Maximum Temperature Without Derating	Derate by	Maximum Permissible
IP20	50°C / 122°F	N/A	50°C / 122°F
IP20 Frame Size 5	35°C / 95°F	1.1% per °C (1.8°F)	50°C / 122°F
IP55	40°C / 104°F	1.5% per °C (1.8°F)	50°C / 122°F
IP66	40°C / 104°F	2.5% per °C (1.8°F)	50°C / 122°F

11.7.2. Derating for Altitude

Enclosure Type	Maximum Temperature Without Derating	Derate by	Maximum Permissible
IP20	1000m / 3281ft	1% per 100m / 328 ft	4000m / 13123 ft
IP55	1000m / 3281ft	1% per 100m / 328 ft	4000m / 13123 ft
IP66	1000m / 3281ft	1% per 100m / 328 ft	4000m / 13123 ft

11.7.3. Derating for Switching Frequency

Enclosure Type	Switching Frequency (Where available)										
	Frame Size	4kHz	8kHz	10kHz	12kHz	14kHz	16kHz	18kHz	20kHz	24kHz	32kHz
IP66	2	N/A	N/A	0%	0%	0%	0%	0%	0%	N/A	N/A
	3	N/A	N/A	0%	0%	0%	6%	N/A	N/A	N/A	N/A
IP55	4	N/A	N/A	0%	0%	12%	23%	33%	41%	N/A	N/A
	5	N/A	N/A	0%	0%	11%	23%	36%	42%	N/A	N/A
	6	0%	16%	N/A	28%	N/A	39%	N/A	N/A	N/A	N/A
	7	0%	12%	N/A	N/A	N/A	N/A	N/A	N/A	N/A	N/A
IP20	2	N/A	N/A	0%	14%	23%	32%	37%	43%	N/A	N/A
	3	N/A	N/A	0%	2%	13%	19%	25%	35%	N/A	N/A
	4	N/A	N/A	0%	15%	13%	39%	52%	62%	N/A	N/A
	5	N/A	N/A	0%	3%	9%	14%	19%	24%	N/A	N/A
	8	0%	N/A	N/A	N/A	N/A	N/A	N/A	N/A	N/A	N/A

11.7.4. Example of Applying Derating Factors

A 4kW, IP66 drive is to be used at an altitude of 2000 metres above sea level, with 16 kHz switching frequency and 45°C ambient temperature.

From the table above, we can see that the rated current of the drive is 9.5 Amps at 40°C,

Firstly, apply the switching frequency derating (if any), 16 kHz, 0% derating.

Now, apply the derating for higher ambient temperature, 2.5% per °C above 40°C = 5 x 2.5% = 12.5%

9.5 Amps x 87.5% = 8.3 Amps.

Now apply the derating for altitude above 1000 metres, 1% per 100m above 1000m = 10 x 1% = 10%

8.3 Amps x 90% = 7.5 Amps continuous current available.

If the required motor current exceeds this level, it will be necessary to either:

- Reduce the switching frequency selected; or
- Use a higher power rated drive and repeat the calculation to ensure sufficient output current is available.

12. Troubleshooting

12.1. Fault Messages

Fault Code	No.	OLED Message	Description	Corrective Action
no-FLT	00	No Fault	No Fault	Displayed in PO-13 if no faults are recorded in the log.
O-I	03	Over current trip	Instantaneous over current on drive output	<p>Fault Occurs on Drive Enable</p> <p>Check the motor and motor connection cable for phase – phase and phase – earth short circuits.</p> <p>Check the load mechanically for a jam, blockage or stalled condition.</p> <p>Ensure the motor nameplate parameters are correctly entered, P1-07, P1-08, P1-09.</p> <p>Reduced the Boost voltage setting in P1-11.</p> <p>Increase the ramp up time in P1-03.</p> <p>If the connected motor has a holding brake, ensure the brake is correctly connected and controlled, and is releasing correctly.</p>
I_Lt-ErrP	04	Over load trip	Drive has tripped on overload after delivering >100% of value in P1-08 for a period of time	<p>Check to see when the decimal points are flashing (drive in overload) and either increase acceleration rate or reduce the load.</p> <p>Check motor cable length is within the limit specified for the relevant drive in section 11.4. Output Power and Current ratings.</p> <p>Ensure the motor nameplate parameters are correctly entered in P1-07, P1-08, and P1-09.</p> <p>Check the load mechanically to ensure it is free, and that no jams, blockages or other mechanical faults exist.</p> <p>For a centrifugal fan or pump, a small reduction in output frequency could significantly reduce the load.</p>
PS-ErrP	05	Hardware Over Current	Instantaneous over current on drive output	Check the wiring to motor and the motor for phase to phase and phase to earth short circuits. Disconnect the motor and motor cable and retest. If the drive trips with no motor connected, it must be replaced and the system fully checked and retested before a replacement unit is installed.
O-vOLT	06	Over voltage	Over voltage on DC bus	<p>The value of the DC Bus Voltage can be displayed in PO-20.</p> <p>A historical log is stored at 256ms intervals prior to a trip in parameter PO-36.</p> <p>This fault is generally caused by excessive regenerative energy being transferred from the load back to the drive. When a high inertia or over hauling type load is connected.</p> <p>If the fault occurs on stopping or during deceleration, increase the deceleration ramp time P1-04.</p> <p>If operating in PID control, ensure that ramps are active by reducing P3-11.</p>
U-vOLT	07	Under voltage	Under voltage on DC bus	<p>This occurs routinely when power is switched off.</p> <p>If it occurs during running, check the incoming supply voltage, and all connections into the drive, fuses, contactors etc.</p>
O-t	08	Over temperature trip	Heatsink over temperature	<p>The heatsink temperature can be displayed in PO-21.</p> <p>A historical log is stored at 30 second intervals prior to a trip in PO-38.</p> <p>Check the drive ambient temperature.</p> <p>Ensure the drive internal cooling fan is operating.</p> <p>Ensure that the required space around the drive as shown in section 3.4 Guidelines for Enclosure mounting (IP20 Units) thru 3.7. Guidelines for Mounting (IP55 Units) has been observed, and that the cooling airflow path to and from the drive is not restricted.</p> <p>Reduce the effective switching frequency setting in parameter P2-24.</p> <p>Reduce the load on the motor / drive.</p>
U-t	09	Under temperature trip	Drive Under temperature	Trip occurs when ambient temperature is less than -10°C. The temperature must be raised over -10°C in order to start the drive.
P-def	10	Load default parameters	Factory Default parameters have been loaded	Press STOP key, the drive is now ready to be configured for the required application. Four button defaults – see section 5.5. Changing Parameters.
E-ErrIP	11	External trip	Digital Input External trip	E-trip requested on control input terminals. Some settings of P1-13 require a normally closed contact to provide an external means of tripping the drive in the event that an external device develops a fault. If a motor thermistor is connected check if the motor is too hot.
SC-ObS	12	Optibus serial comms fault	Communications Fault	Communications lost with PC or remote keypad. Check the cables and connections to external devices.

Fault Code	No.	OLED Message	Description	Corrective Action
<i>F_{LT}-dc</i>	13	Excessive DC ripple	Excessive DC Ripple on Internal DC bus	The DC Bus Ripple Voltage level can be displayed in parameter PO-16. A historical log is stored at 20ms intervals prior to a trip in parameter PO-37. Check all three supply phases are present and within the 3% supply voltage level imbalance tolerance. Reduce the motor load. If the fault persists, contact your local Inverter Drives Sales Partner.
<i>P-LOSS</i>	14	Input phase loss	Input phase missing trip	Drive intended for use with a 3 phase supply, one input phase has been disconnected or lost.
<i>h_O-I</i>	15	Hardware detected Instant over current	Instantaneous over current on drive output	Refer to fault 3 above.
<i>t_h-FLT</i>	16	Thermistor Fault	Faulty thermistor on heat-sink	Refer to your Inverter Sales Partner.
<i>d_{RA}R-F</i>	17	I/O processor data error	Internal memory fault	Parameters not saved, defaults reloaded. Try again. If problem recurs, refer to your IDL Authorised Distributor.
<i>4-20F</i>	18	4-20mA signal out of range	4-20mA Signal Lost	The reference signal on Analog Input 1 or 2 (Terminals 6 or 10) has dropped below the minimum threshold of 3mA when signal format is set to 4-20mA. Check the signal source and wiring to the Optidrive terminals.
<i>d_{RA}R-E</i>	19	M/C processor data error	Internal memory fault	Parameters not saved, factory defaults are reloaded. If problem reoccurs, refer to your IDL Authorised Distributor.
<i>U-dEF</i>	20	User Parameter Default	User Parameter Defaults	User Parameter default has been loaded. Press the Stop key. Three button default – see section 5.6. Parameter Factory Reset / User Reset.
<i>F-Ptc</i>	21	Motor PTC over heat	Motor PTC Over Temperature	The connected motor PTC device has caused the drive to trip (analog input 2 configured for PTC device).
<i>F_{AN}-F</i>	22	Cooling Fan Fault	Cooling Fan Fault	Check and if necessary, replace the drive internal cooling fan.
<i>O-h_{ER}t</i>	23	Ambient Temperature High	Ambient Temperature too High	Ensure the drive internal cooling fan is operating. Ensure that the required space around the drive as shown in sections 3.4 Guidelines for Enclosure mounting (IP20 Units) thru 3.7 Guidelines for Mounting (IP55 Units) has been observed, and that the cooling airflow path to and from the drive is not restricted. Increase the cooling airflow to the drive. Reduce the effective switching frequency setting in parameter P2-24. Reduce the load on the motor / drive.
<i>O-t_{OR}G</i>	24	High motor current	Motor current above configured profile	Current Monitoring Function has detected motor current levels above the normal operating condition for the application. Check mechanical load has not changed and that the load is not jammed or stalling. For pump application check for potential pump blockage. For fan applications check airstream to and from the fan is not restricted.
<i>U-t_{OR}G</i>	25	Low motor current	Motor current below configured profile	Current Monitoring Function has detected motor current levels below the normal operating condition for the application. Check for mechanical breakages causing loss of load (e.g. belt break). Check motor has not become disconnected from the drive.
<i>O_Ut-F</i>	26	Drive Output Fault	Drive output fault	Drive output fault. Check for loose motor cables at the drive and at the motor or any termination in between. Otherwise refer to your IDL Authorised Distributor.
<i>S_to-F</i>	29	Internal STO circuit Error	Refer to your Inverter Sales Partner	
<i>R_{EF}-O₁</i>	40	Autotune fail 1	Autotune Failed	Measured motor stator resistance varies between phases. Ensure the motor is correctly connected and free from faults. Check the windings for correct resistance and balance.
<i>R_{EF}-O₂</i>	41	Autotune fail 2		Measured motor stator resistance is too large. Ensure the motor is correctly connected and free from faults. Check that the power rating corresponds to the power rating of the connected drive.
<i>R_{EF}-O₃</i>	42	Autotune fail 3		Measured motor inductance is too low. Ensure the motor is correctly connected and free from faults.
<i>R_{EF}-O₄</i>	43	Autotune fail 4		Measured motor inductance is too large. Ensure the motor is correctly connected and free from faults. Check that the power rating corresponds to the power rating of the connected drive.
<i>R_{EF}-O₅</i>	44	Autotune fail 5		Measured motor parameters are not convergent. Ensure the motor is correctly connected and free from faults. Check that the power rating corresponds to the power rating of the connected drive.

Fault Code	No.	OLED Message	Description	Corrective Action
<i>Ph-SE9</i>	45	Incorrect Supply Phase Sequence	L1-L2-L3 Phase sequence is incorrect	Applies to Frame Size 8 drives only, indicates that the incoming power supply phase sequence is incorrect. Any 2 phases may be swapped.
<i>Pr-Lo</i>	48	Feedback Pressure Low	Low Pressure Detected by Pipe Fill Function	Check the pump system for leaks for burst pipes. Check the Pipe fill function has been commissioned correctly (P3-16 & P3-17).
<i>Out-Ph</i>	49	Output Phase Loss	Output (Motor) Phase Loss	One of the motor output phases is not connected to the drive.
<i>Sc-F01</i>	50	Modbus Comms fault	Modbus communication error detected	
<i>Sc-F03</i>	52	Option Module Fault	Fitted communication Module Fault	Internal communication to the inserted Communications Option Module has been lost. Check the module is correctly inserted.
<i>Sc-F04</i>	53	IO Card Comms fault	IO card comms trip	Internal communication to the inserted I/O Option Module has been lost. Check the module is correctly inserted.
<i>Sc-F05</i>	54	BACnet Comms fault	BACnet comms loss trip	A valid BACnet telegram has not been received within the watchdog time limit set in P5-05. Check the network master / PLC is still operating. Check the connection cables. Increase the value of P5-05 to a suitable level.



82-HEMAN-IN_V3.03